

Section A-A

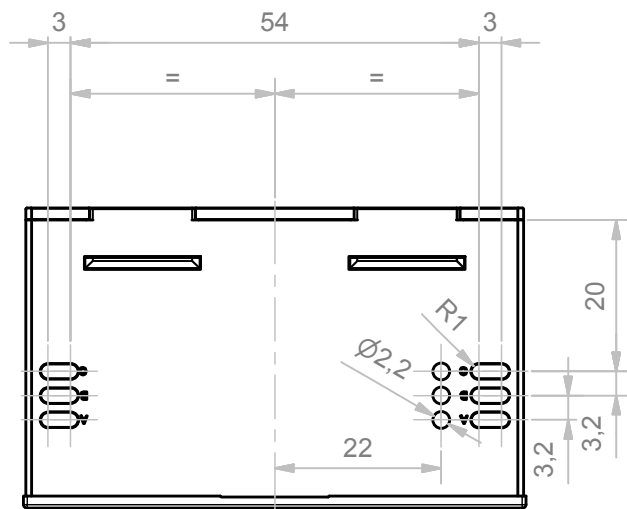

Section B-B

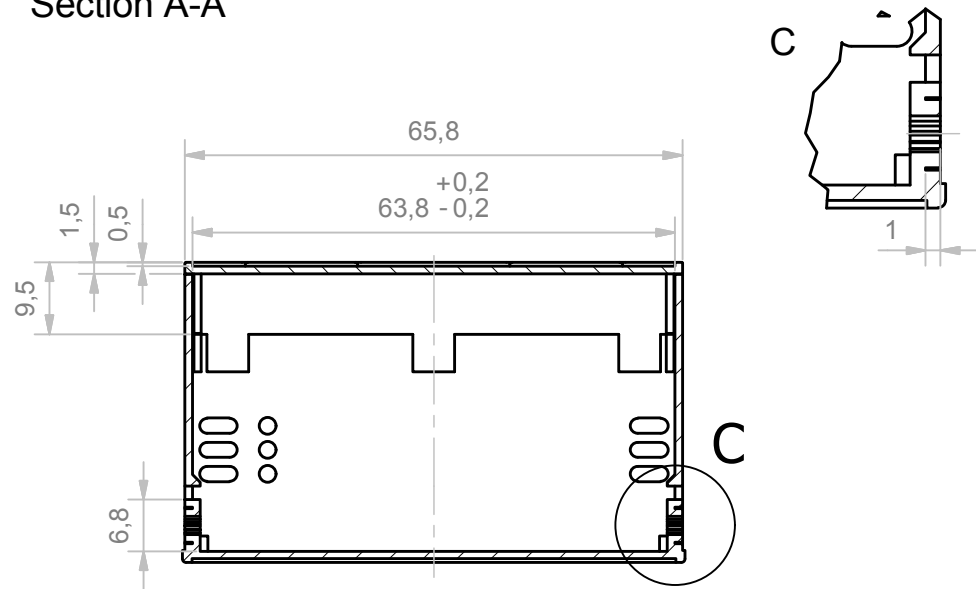
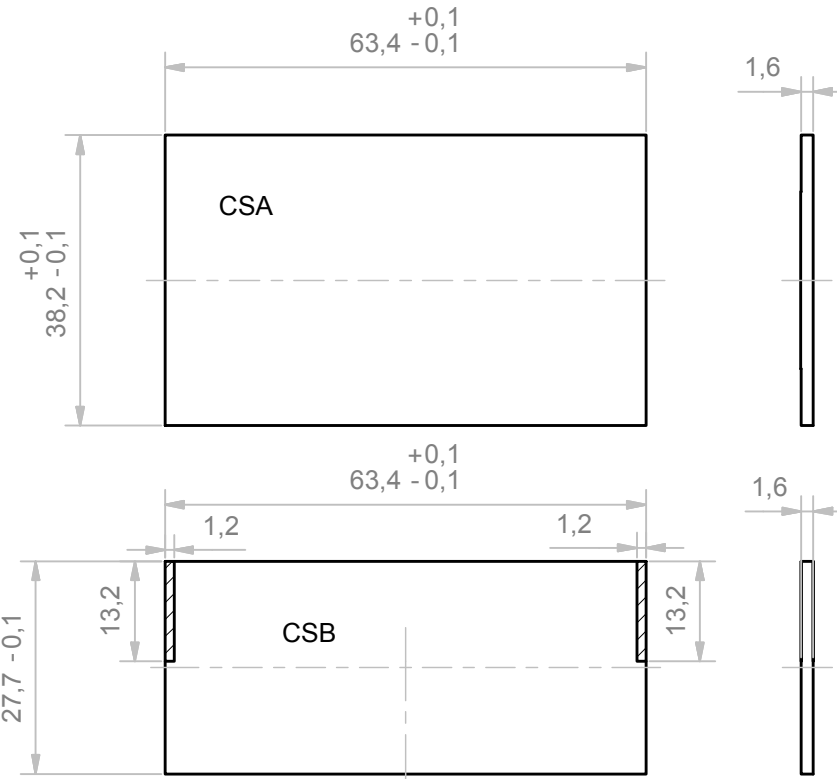
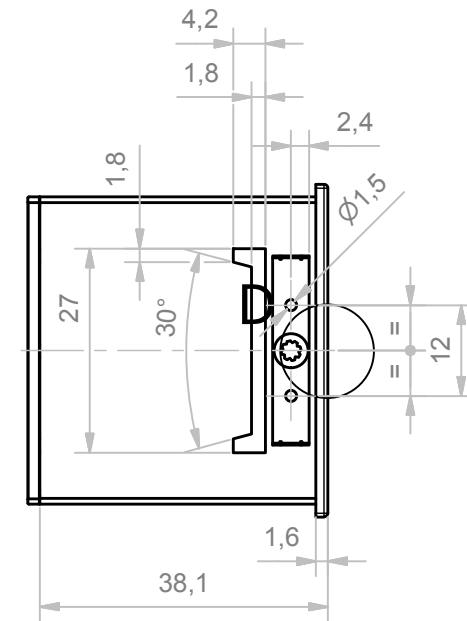
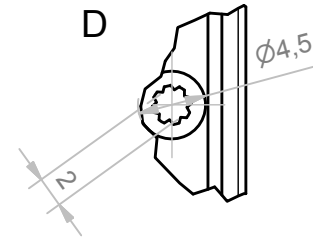
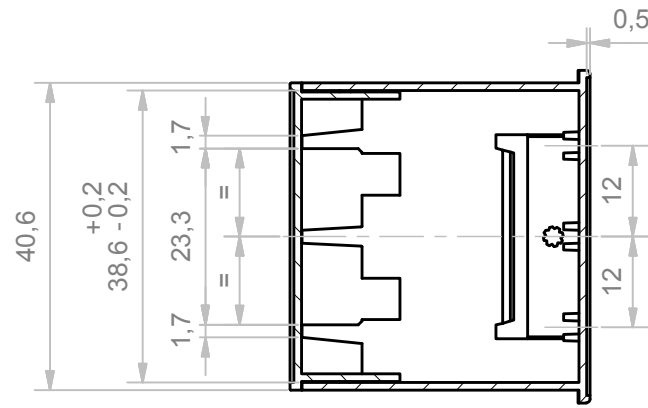

NO COMPONENTS

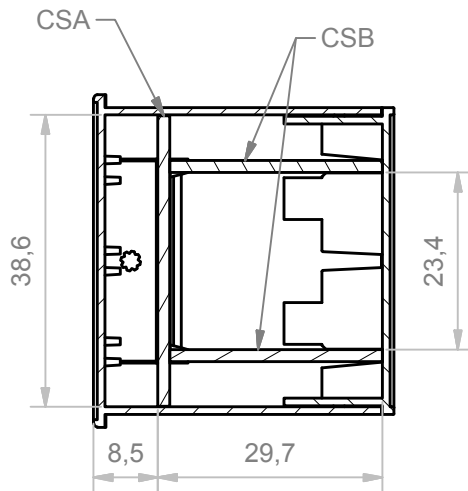

Da 0,5 a 3	Oltre 3 fino a 6	Oltre 6 fino a 30	Oltre 30 fino a 120	Oltre 120 fino a 400
± 0,1	± 0,1	± 0,2	± 0,3	± 0,5

RESERVED PROPERTY The present drawing cannot be reproduced or communicated to 3d parties, even partially, without the authorization of ITALTRONIC Srl. Italtronic reserves to protect its own rights according to the law.	Dimension in mm	SHEET NR. 1 / 1	DRAWING BY GAD Manual modification are not allowed	GENERAL TOLERANCE <b>UNI EN 22768/1</b> Media (m)
		Date: 01/02/2010	Replace nr.	Revision description
Drawn: Zorzato E.	Checked: Mazzucato F.	Scale:		5 4 3 2 1

Denomination: **Contenitore C-Box per accessori universali**

**Plastic+**  
UN PARTNER PER IL FUTURO **Group**

**ITALTRONIC S.R.L.**  
VIA AUSTRIA 25/D 35127  
PADOVA - ITALY  
www.italtronic.com

Drawing nr. **C-02766-02**

Aggiunto collarino forato per rendere più stabile il fissaggio copressura IDEA. 01/04/2011 Zorzato E.  
 Aggiunto perni e nervature per fissaggio copressura IDEA. 20/07/2010 Zorzato E.