



140x140x51 mm

San Ace 140L 9LG type

General Specifications

- Material Frame: Aluminum (Black coating), Impeller: Plastic (Flammability: UL 94V-0)
- Expected life See the table below. (L10 life: 90% survival rate for continuous operation in free air at 60°C, rated voltage) Expected life at 40°C is for reference only.
- Motor protection function Locked rotor burnout protection, Reverse polarity protection
For details, please refer to p. 573.
- Dielectric strength 50/60 Hz, 500 VAC, for 1 minute (between lead wire conductors and frame)
- Insulation resistance 10 MΩ or more with a 500 VDC megger (between lead wire conductors and frame)
- Sound pressure level (SPL) At 1 m away from the air inlet
- Storage temperature -30 to +70°C (Non-condensing)
- Lead wire ⊕Red ⊖Black (Sensor) Yellow (Control) Brown
(For models without PWM control function, there is no speed control wiring.)
- Mass 790 g

Specifications

The models listed below **have pulse sensors with PWM control function.**

Model no.	Rated voltage [V]	Operating voltage range [V]	PWM duty cycle [%]	Rated current [A]	Rated input [W]	Rated speed [min ⁻¹]	Max. airflow [m ³ /min] [CFM]	Max. static pressure [Pa] [inchH ₂ O]	SPL [dB (A)]	Operating temperature [°C]	Expected life [h]		
9LG1412P5G001	12	10.2 to 13.8	100	5.16	62	7500	9.0 318	655 2.63	69	-20 to +70	180000/60°C (215000/40°C)		
			20	0.31	3.72	2300	2.75 97	80 0.32	38				
9LG1412P5S001			100	1.83	22	5000	6.0 212	295 1.18	57				
			20	0.31	3.72	2300	2.75 97	80 0.32	38				
9LG1424P5G001			24	20.4 to 27.6	100	2.58	62	7500	9.0 318			655 2.63	69
					20	0.16	3.84	2300	2.75 97			80 0.32	38
9LG1424P5S001	100	0.91			22	5000	6.0 212	295 1.18	57				
	20	0.16			3.84	2300	2.75 97	80 0.32	38				
9LG1448P5G001	48	40.8 to 55.2			100	1.29	62	7500	9.0 318			655 2.63	69
					20	0.12	5.76	2300	2.75 97			80 0.32	38
9LG1448P5S001			100	0.45	22	5000	6.0 212	295 1.18	57				
			20	0.12	5.76	2300	2.75 97	80 0.32	38				

* PWM input frequency is 25 kHz; models without specifications at 0% PWM duty cycle have zero fan speed at 0%.

The following sensor and control options are available for selection.

Differs according to the model. Refer to the table on p. 609. **Without sensor** **Pulse sensor** **Lock sensor**

The models listed below **have pulse sensors.**

Model no.	Rated voltage [V]	Operating voltage range [V]	Rated current [A]	Rated input [W]	Rated speed [min ⁻¹]	Max. airflow [m ³ /min] [CFM]	Max. static pressure [Pa] [inchH ₂ O]	SPL [dB (A)]	Operating temperature [°C]	Expected life [h]
9LG1412A5001	12	10.2 to 13.8	2.61	31.4	5700	6.9 243.8	500 2	61	-20 to +70	180000/60°C (215000/40°C)
9LG1412H5001			1	12	4100	4.9 173.1	260 1.04	52		
9LG1412M5001			0.43	5.16	2600	3.1 109.5	100 0.4	40		
9LG1424A5001	24	20.4 to 27.6	1.21	29.1	5700	6.9 243.8	540 2.17	61		
9LG1424H5001			0.55	13.2	4100	4.9 173.1	260 1.04	52		
9LG1424M5001			0.23	5.52	2600	3.1 109.5	100 0.4	40		
9LG1448A5001	48	40.8 to 55.2	0.66	31.7	5700	6.9 243.8	540 2.17	61		
9LG1448H5001			0.31	14.9	4100	4.9 173.1	260 1.04	52		
9LG1448M5001			0.15	7.2	2600	3.1 109.5	100 0.4	40		

The following sensor and control options are available for selection.

Available for all models. **Without sensor** **Lock sensor**

The mark indicates Short Lead Time Service applicable models. See p. 626 for details.

DC Long Life Fan 140 mm sq.

Airflow - Static Pressure Characteristics / PWM Duty - Speed Characteristics Example

9LG1412P5G001 With pulse sensor with PWM control function

PWM duty cycle

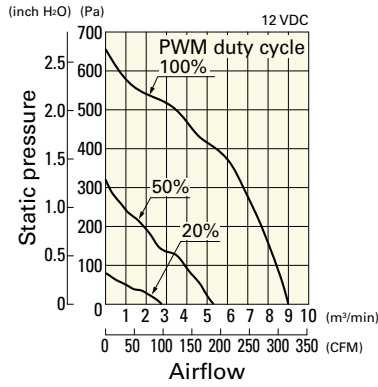

Operating voltage range

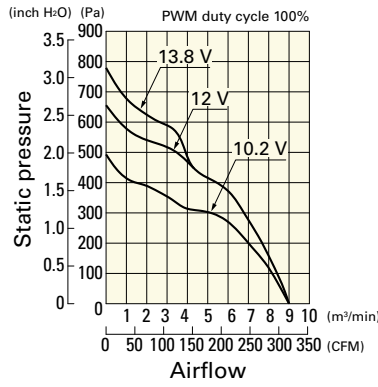

PWM duty - Speed characteristics example

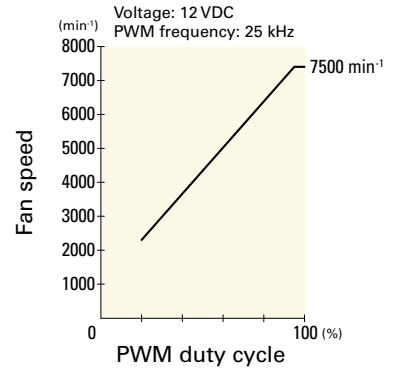

9LG1412P5S001 With pulse sensor with PWM control function

PWM duty cycle

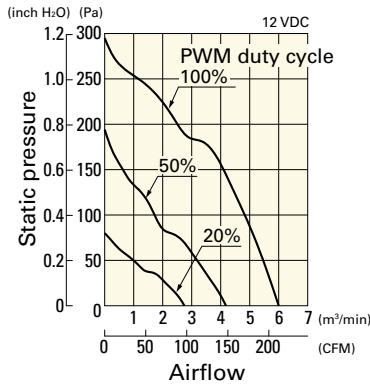

Operating voltage range

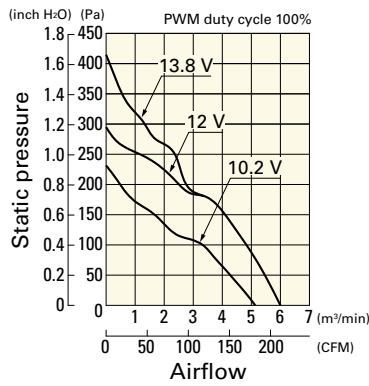

PWM duty - Speed characteristics example

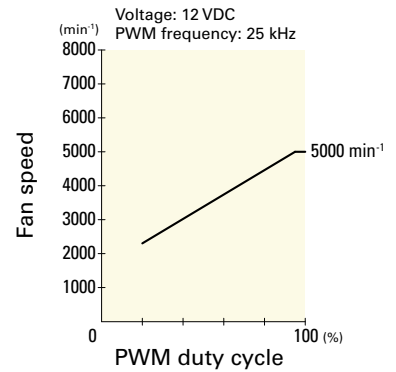

DC

Long Life Fan 140 mm sq.

9LG1424P5G001 With pulse sensor with PWM control function

PWM duty cycle

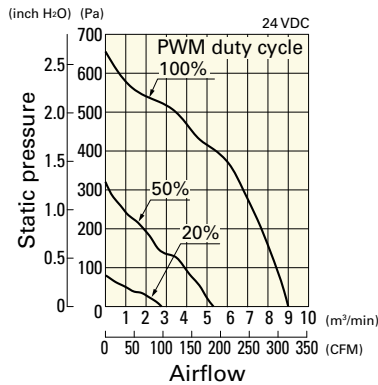

Operating voltage range

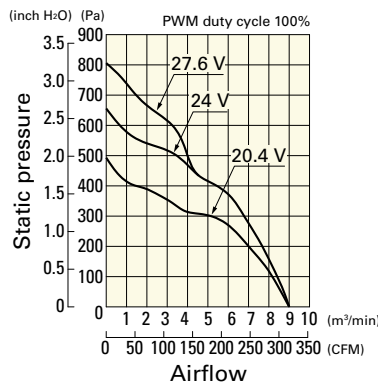

PWM duty - Speed characteristics example

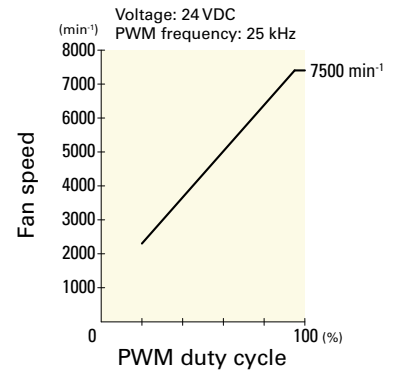

9LG1424P5S001 With pulse sensor with PWM control function

PWM duty cycle

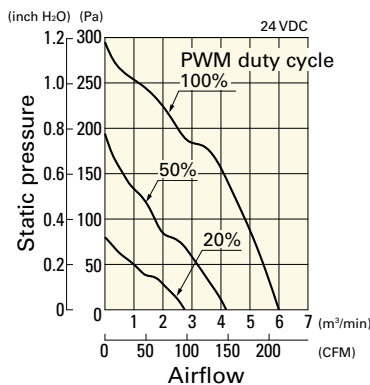

Operating voltage range

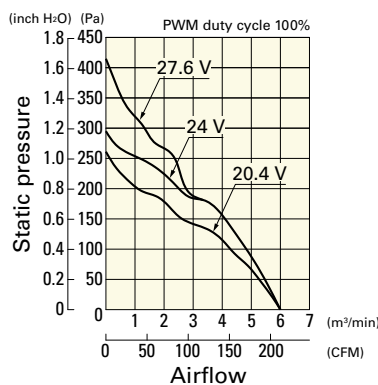

PWM duty - Speed characteristics example

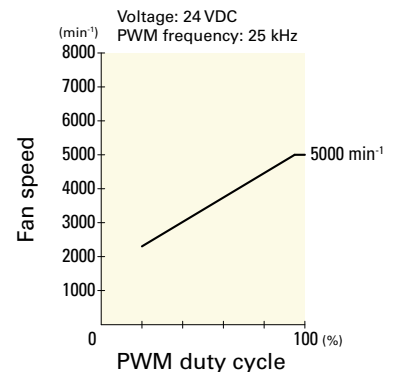

Airflow - Static Pressure Characteristics / PWM Duty - Speed Characteristics Example

9LG1448P5G001 With pulse sensor with PWM control function

PWM duty cycle

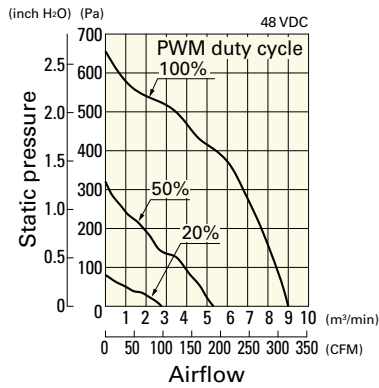

Operating voltage range

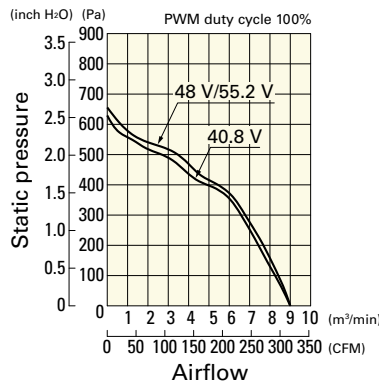

PWM duty - Speed characteristics example

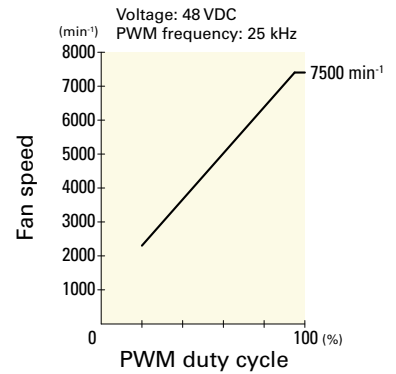

9LG1448P5S001 With pulse sensor with PWM control function

PWM duty cycle

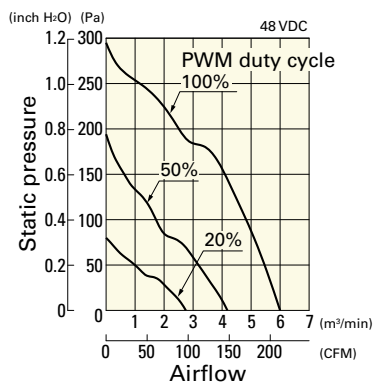

Operating voltage range

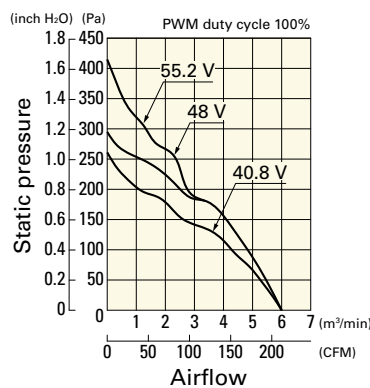

PWM duty - Speed characteristics example

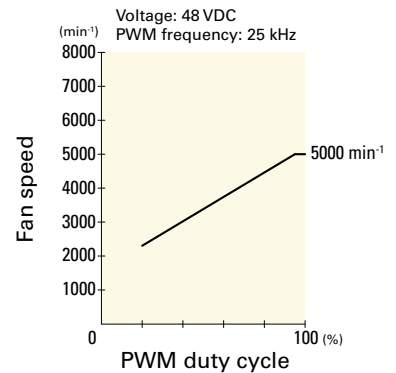

Airflow - Static Pressure Characteristics

9LG1412A5001 With pulse sensor

Operating voltage range

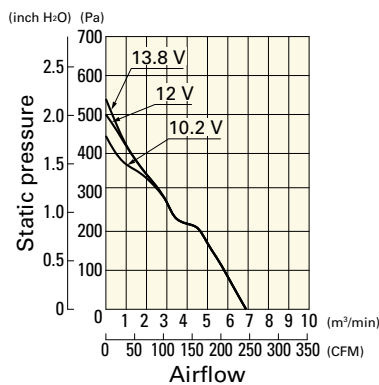

9LG1412H5001 With pulse sensor

Operating voltage range

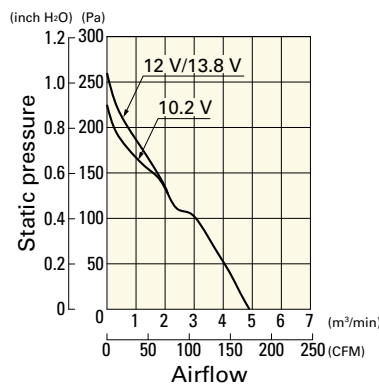

9LG1412M5001 With pulse sensor

Operating voltage range

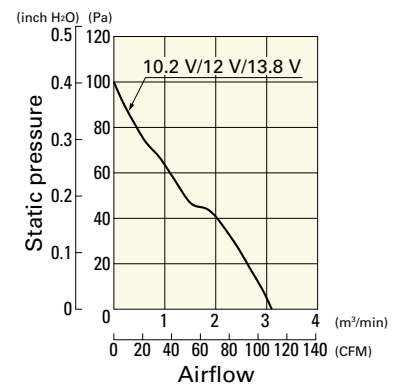

DC
Long Life Fan 140 mm sq.

Airflow - Static Pressure Characteristics

9LG1424A5001 With pulse sensor

Operating voltage range

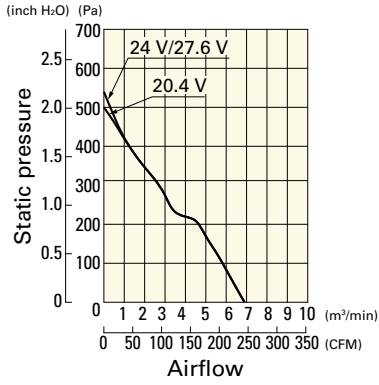

9LG1424H5001 With pulse sensor

Operating voltage range

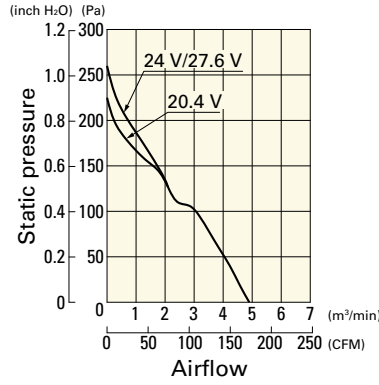

9LG1424M5001 With pulse sensor

Operating voltage range

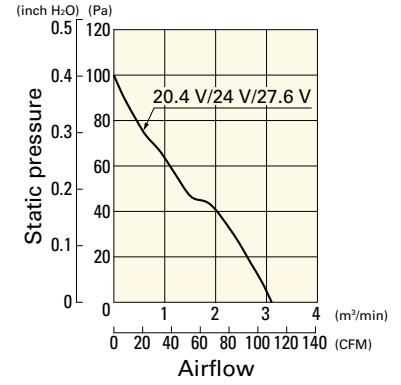

9LG1448A5001 With pulse sensor

Operating voltage range

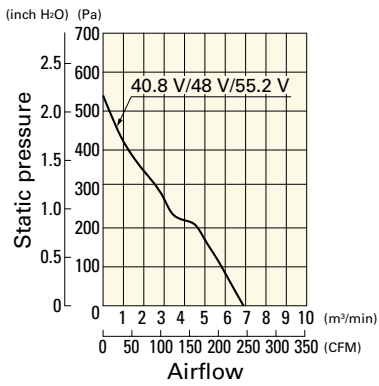

9LG1448H5001 With pulse sensor

Operating voltage range

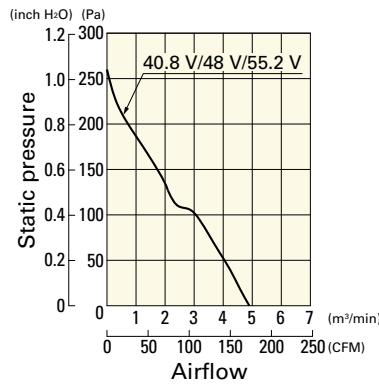

9LG1448M5001 With pulse sensor

Operating voltage range

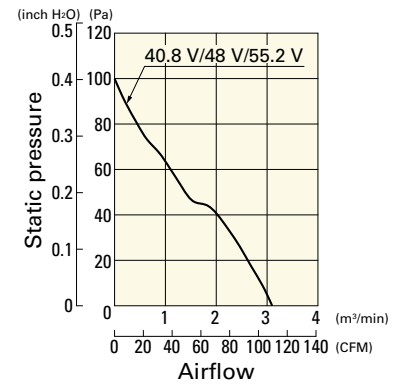

DC Long Life Fan 140 mm sq.

Dimensions (unit: mm)

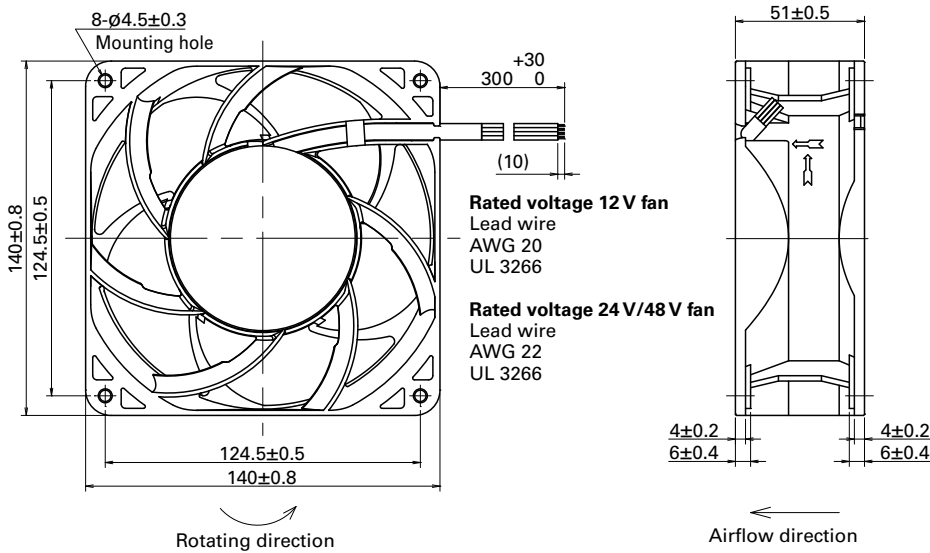

■ Reference Dimensions of Mounting Holes and Vent Opening (unit: mm)

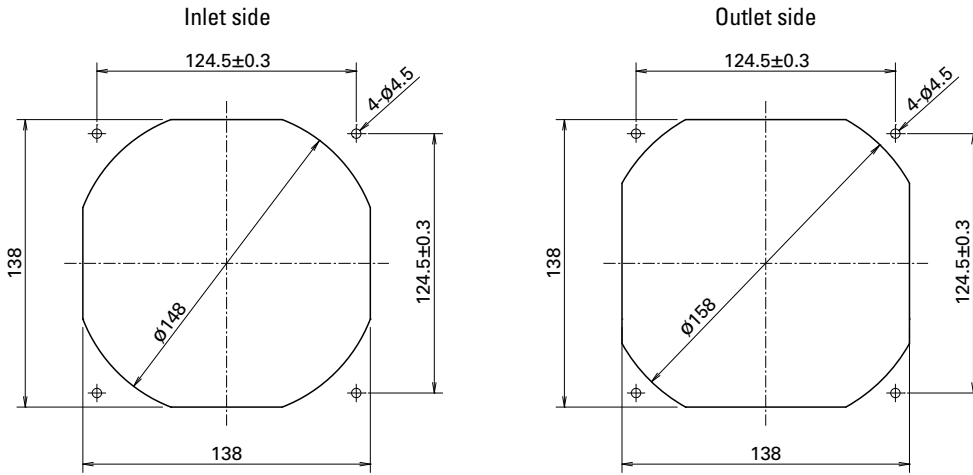

■ Options

Finger guards

page: p. 559

Model no.: 109-719, 109-719H