

High Voltage, BiMOSFET™ Monolithic Bipolar MOS Transistor

IXBT42N300HV IXBH42N300HV

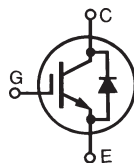

$$V_{CES} = 3000V$$

$$I_{C110} = 42A$$

$$V_{CE(sat)} \leq 3.0V$$

Symbol	Test Conditions	Maximum Ratings	
V_{CES}	$T_C = 25^\circ C$ to $150^\circ C$	3000	V
V_{CGR}	$T_J = 25^\circ C$ to $150^\circ C$, $R_{GE} = 1M\Omega$	3000	V
V_{GES}	Continuous	± 25	V
V_{GEM}	Transient	± 35	V
I_{C25}	$T_C = 25^\circ C$	104	A
I_{C110}	$T_C = 110^\circ C$	42	A
I_{CM}	$T_C = 25^\circ C$, 1ms	400	A
SSOA (RBSOA)	$V_{GE} = 15V$, $T_{VJ} = 125^\circ C$, $R_G = 20\Omega$ Clamped Inductive Load	$I_{CM} = 84$ 1500	A V
T_{SC} (SCSOA)	$V_{GE} = 15V$, $T_J = 125^\circ C$, $R_G = 82\Omega$, $V_{CE} = 1500V$, Non-Repetitive	10	μS
P_C	$T_C = 25^\circ C$	500	W
T_J		-55 ... +150	$^\circ C$
T_{JM}		150	$^\circ C$
T_{stg}		-55 ... +150	$^\circ C$
T_L	1.6mm (0.062 in.) from Case for 10s	300	$^\circ C$
T_{SOLD}	Plastic Body for 10 seconds	260	$^\circ C$
M_d	Mounting Torque (TO-247HV)	1.13/10	Nm/lb.in
Weight	TO-268HV	4	g
	TO-247HV	6	g

TO-268HV (IXBT)

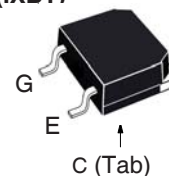

TO-247HV (IXBH)

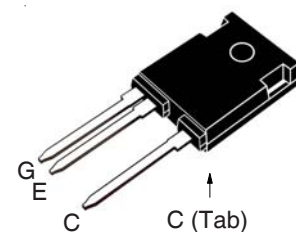

G = Gate C = Collector
E = Emitter Tab = Collector

Features

- High Voltage Package
- High Blocking Voltage
- High Peak Current Capability
- Low Saturation Voltage
- FBSOA
- SCSOA

Advantages

- Low Gate Drive Requirement
- High Power Density

Applications

- Laser Generators
- Capacitor Discharge Circuits
- AC Switches
- Protection Circuits

Symbol	Test Conditions ($T_J = 25^\circ C$ Unless Otherwise Specified)	Characteristic Values		
		Min.	Typ.	Max.
BV_{CES}	$I_C = 1mA$, $V_{GE} = 0V$	3000		V
$V_{GE(th)}$	$I_C = 1mA$, $V_{CE} = V_{GE}$	3.0		5.0 V
I_{CES}	$V_{CE} = 0.8 \cdot V_{CES}$, $V_{GE} = 0V$ $T_J = 125^\circ C$		250	50 μA 50 μA
I_{GES}	$V_{CE} = 0V$, $V_{GE} = \pm 25V$			± 200 nA
$V_{CE(sat)}$	$I_C = 42A$, $V_{GE} = 15V$, Note 1 $T_J = 125^\circ C$		2.5	3.0 V
			3.1	V

Symbol Test Conditions ($T_J = 25^\circ\text{C}$ Unless Otherwise Specified)		Characteristic Values		
		Min.	Typ.	Max.
g_{fs}	$I_C = 42\text{A}, V_{CE} = 10\text{V}$, Note 1	28	45	S
C_{ies}	$V_{CE} = 25\text{V}, V_{GE} = 0\text{V}, f = 1\text{MHz}$		4780	pF
C_{oes}			170	pF
C_{res}			56	pF
R_{Gi}	Gate Input Resistance		3.0	Ω
Q_g	$I_C = 42\text{A}, V_{GE} = 15\text{V}, V_{CE} = 1000\text{V}$		200	nC
Q_{ge}			28	nC
Q_{gc}			75	nC
$t_{d(on)}$	Resistive Switching Times, $T_J = 25^\circ\text{C}$ $I_C = 42\text{A}, V_{GE} = 15\text{V}$ $V_{CE} = 1500\text{V}, R_G = 20\Omega$		72	ns
t_r			330	ns
$t_{d(off)}$			445	ns
t_f			610	ns
$t_{d(on)}$	Resistive Switching Times, $T_J = 125^\circ\text{C}$ $I_C = 42\text{A}, V_{GE} = 15\text{V}$ $V_{CE} = 1500\text{V}, R_G = 20\Omega$		72	ns
t_r			580	ns
$t_{d(off)}$			460	ns
t_f			490	ns
R_{thJC}				0.25 $^\circ\text{C/W}$
R_{thCS}	TO-247HV		0.21	$^\circ\text{C/W}$

Reverse Diode

Symbol Test Conditions ($T_J = 25^\circ\text{C}$ Unless Otherwise Specified)		Characteristic Values		
		Min.	Typ.	Max
V_F	$I_F = 42\text{A}, V_{GE} = 0\text{V}$, Note 1			2.5 V
t_{rr}	$I_F = 21\text{A}, V_{GE} = 0\text{V}, -di_F/dt = 100\text{A}/\mu\text{s}$		1.7	μs
I_{RM}		$V_R = 100\text{V}, V_{GE} = 0\text{V}$		43

Note 1. Pulse test, $t < 300\mu\text{s}$, duty cycle, $d < 2\%$.

PRELIMINARY TECHNICAL INFORMATION

The product presented herein is under development. The Technical Specifications offered are derived from a subjective evaluation of the design, based upon prior knowledge and experience, and constitute a "considered reflection" of the anticipated result. IXYS reserves the right to change limits, test conditions, and dimensions without notice.

IXYS Reserves the Right to Change Limits, Test Conditions and Dimensions.

IXYS MOSFETs and IGBTs are covered by one or more of the following U.S. patents:

4,835,592	4,931,844	5,049,961	5,237,481	6,162,665	6,404,065 B1	6,683,344	6,727,585	7,005,734 B2	7,157,338B2
4,860,072	5,017,508	5,063,307	5,381,025	6,259,123 B1	6,534,343	6,710,405 B2	6,759,692	7,063,975 B2	
4,881,106	5,034,796	5,187,117	5,486,715	6,306,728 B1	6,583,505	6,710,463	6,771,478 B2	7,071,537	

TO-268HV Outline

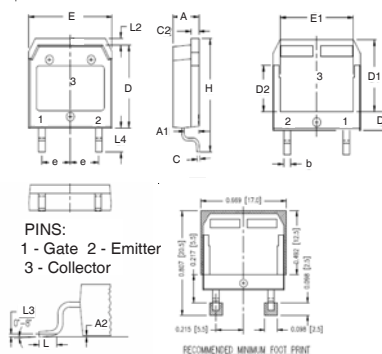

SYM	INCHES		MILLIMETER	
	MIN	MAX	MIN	MAX
A	.193	.201	4.90	5.10
A1	.106	.114	2.70	2.90
A2	.001	.010	0.02	0.25
b	.045	.057	1.15	1.45
C	.016	.026	0.40	0.65
C2	.057	.063	1.45	1.60
D	.543	.551	13.80	14.00
D1	.465	.476	11.80	12.10
D2	.295	.307	7.50	7.80
D3	.114	.126	2.90	3.20
E	.624	.632	15.85	16.05
E1	.524	.535	13.30	13.60
E	.215	BSC	5.45	BSC
H	.736	.752	18.70	19.10
L	.067	.079	1.70	2.00
L2	.039	.045	1.00	1.15
L3	.010	BSC	0.25	BSC
L4	.150	.161	3.80	4.10

TO-247HV Outline

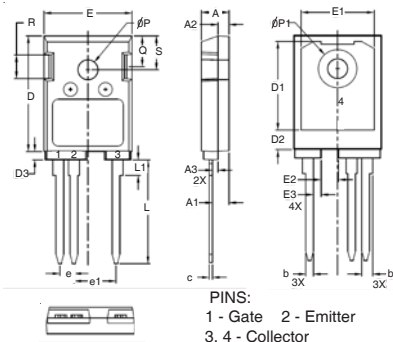

SYM	INCHES		MILLIMETERS	
	MIN	MAX	MIN	MAX
A	.193	.201	4.90	5.10
A1	.114	.122	2.90	3.10
A2	.075	.083	1.90	2.10
A3	.035	.043	0.90	1.10
b	.053	.059	1.35	1.50
b1	.075	.083	1.90	2.10
c	.022	.030	0.55	0.75
D	.819	.843	20.80	21.40
D1	.638	.646	16.20	16.40
D2	.134	.146	3.40	3.70
D3	.055	.063	1.40	1.60
E	.622	.638	15.80	16.20
E1	.520	.528	13.20	13.40
E2	.118	.126	3.00	3.20
E3	.051	.059	1.30	1.50
e	.100	BSC	2.54	BSC
e1	.300	BSC	7.62	BSC
L	.732	.748	18.60	19.00
L1	.106	.118	2.70	3.00
ØP	.138	.142	3.50	3.60
ØP1	.272	.280	6.90	7.10
Q	.216	.224	5.50	5.70
R	.165	.169	4.20	4.30
S	.240	.248	6.10	6.30

Fig. 1. Output Characteristics @ $T_J = 25^\circ\text{C}$

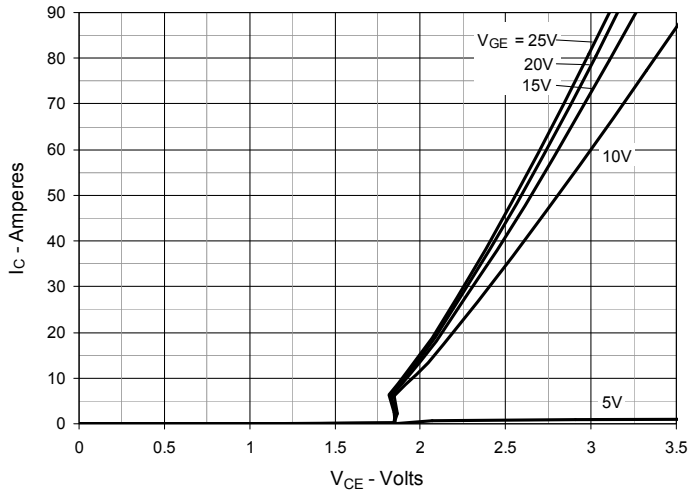

Fig. 2. Extended Output Characteristics @ $T_J = 25^\circ\text{C}$

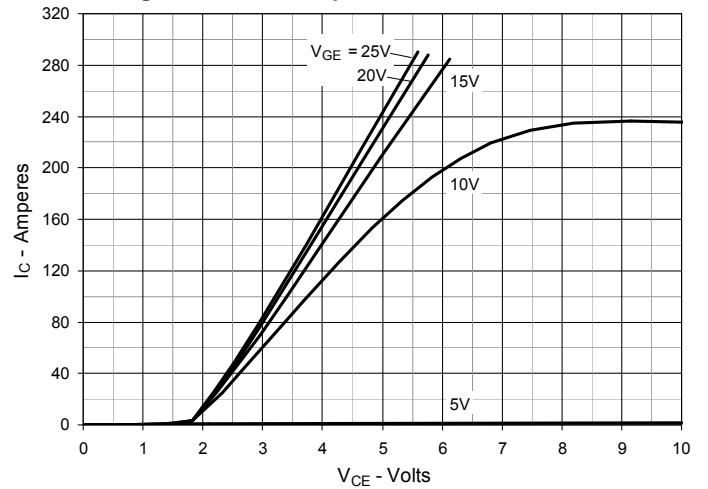

Fig. 3. Output Characteristics @ $T_J = 125^\circ\text{C}$

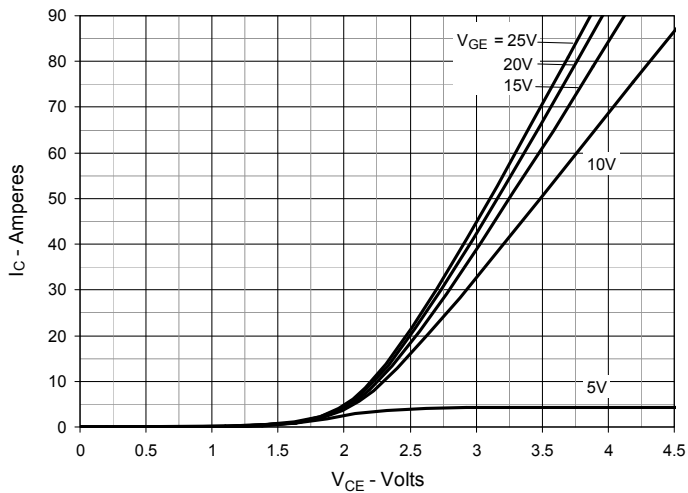

Fig. 4. Dependence of $V_{CE(sat)}$ on Junction Temperature

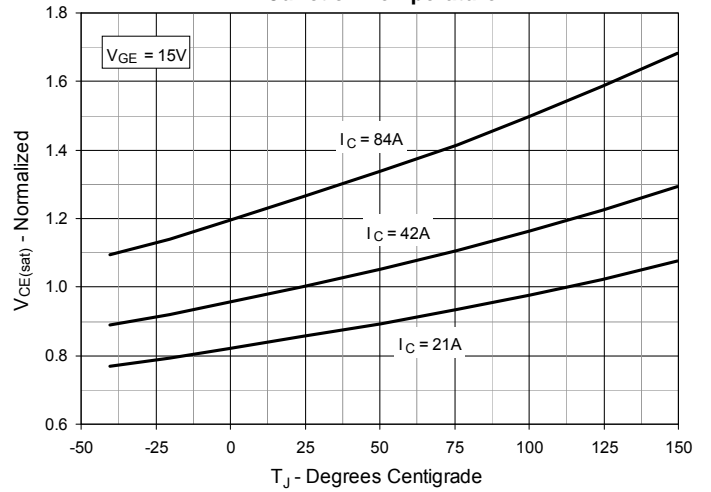

Fig. 5. Collector-to-Emitter Voltage vs. Gate-to-Emitter Voltage

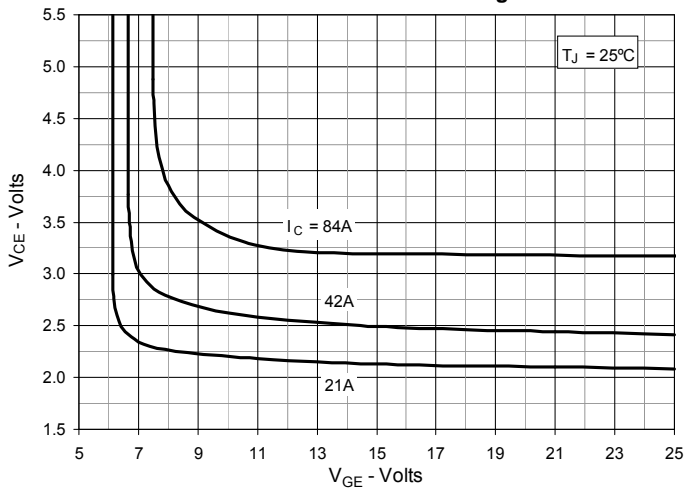

Fig. 6. Input Admittance

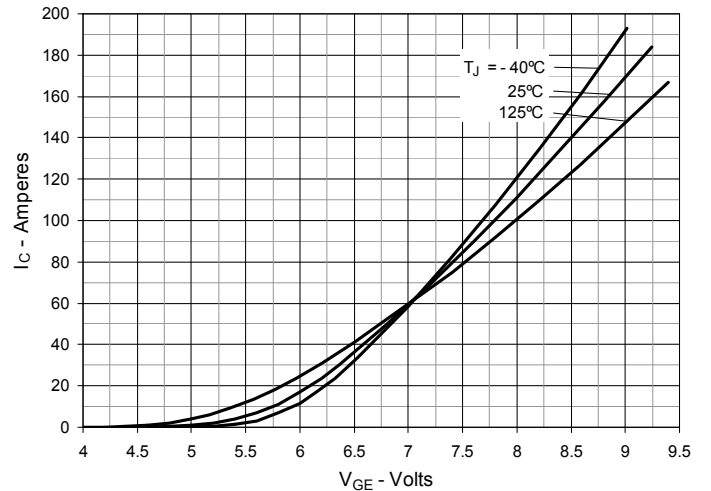

Fig. 7. Transconductance

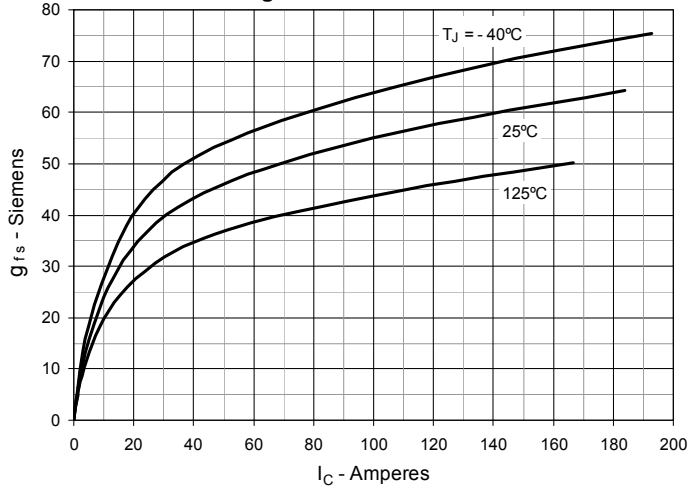

Fig. 8. Forward Voltage Drop of Intrinsic Diode

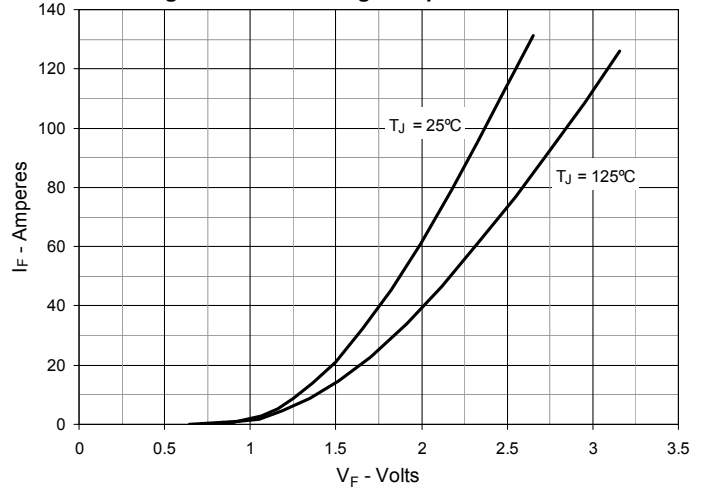

Fig. 9. Gate Charge

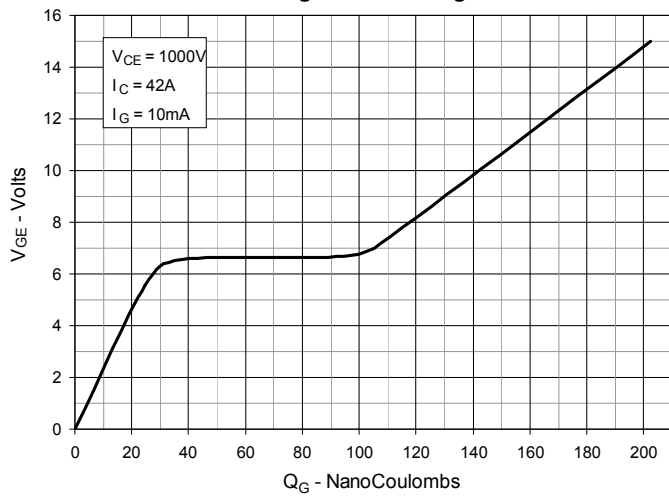

Fig. 10. Capacitance

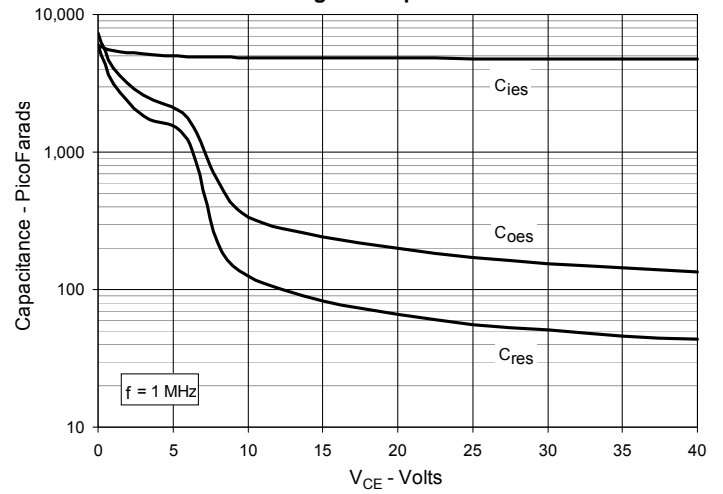

Fig. 11. Reverse-Bias Safe Operating Area

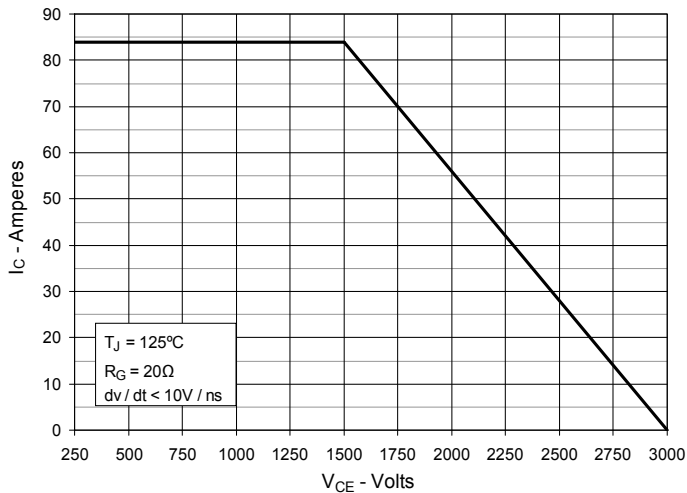

Fig. 12. Maximum Transient Thermal Impedance

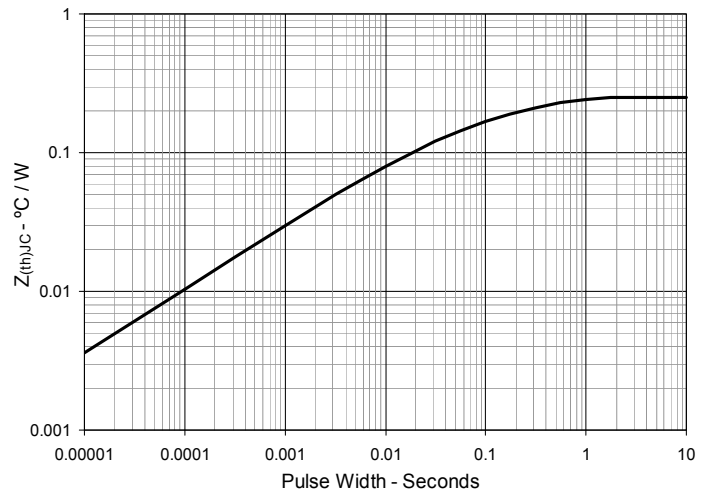

Fig. 13. Resistive Turn-on Rise Time vs. Junction Temperature

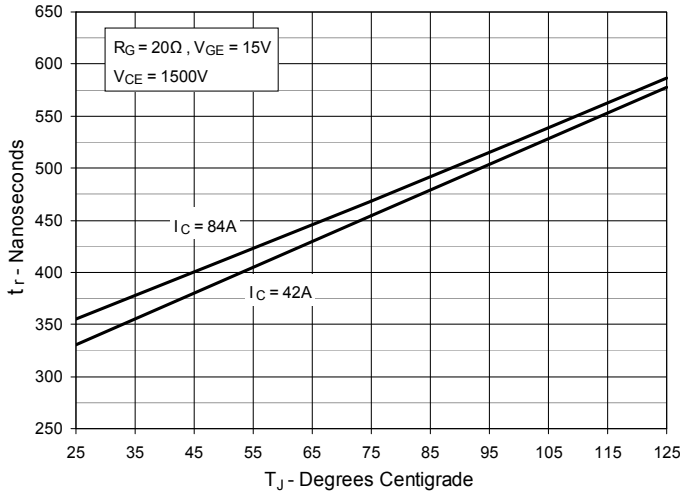

Fig. 14. Resistive Turn-on Rise Time vs. Collector Current

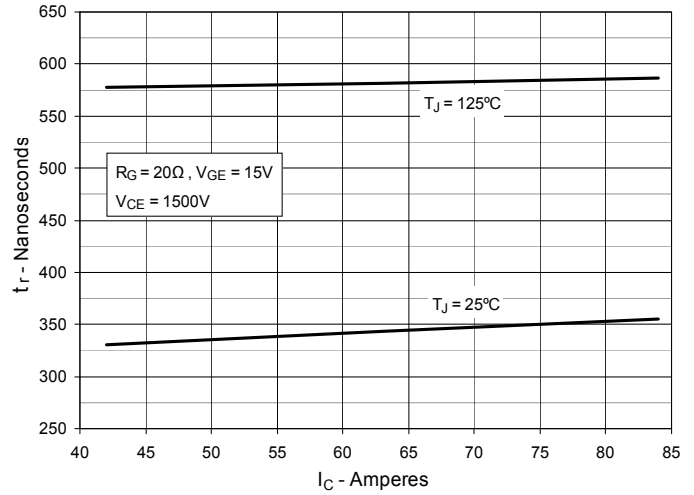

Fig. 15. Resistive Turn-on Switching Times vs. Gate Resistance

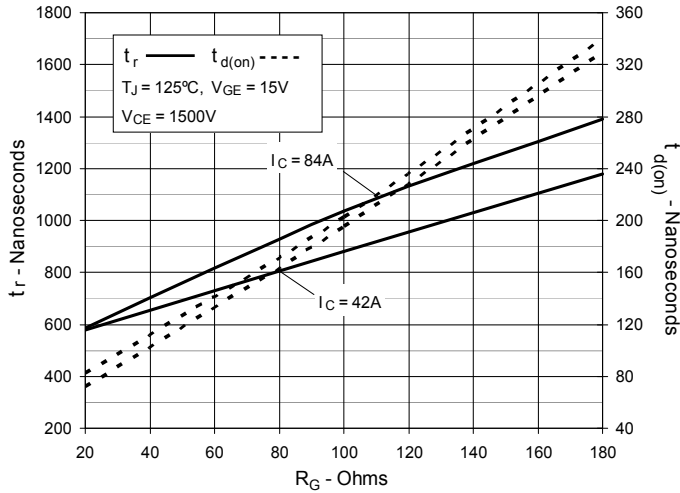

Fig. 16. Resistive Turn-off Switching Times vs. Junction Temperature

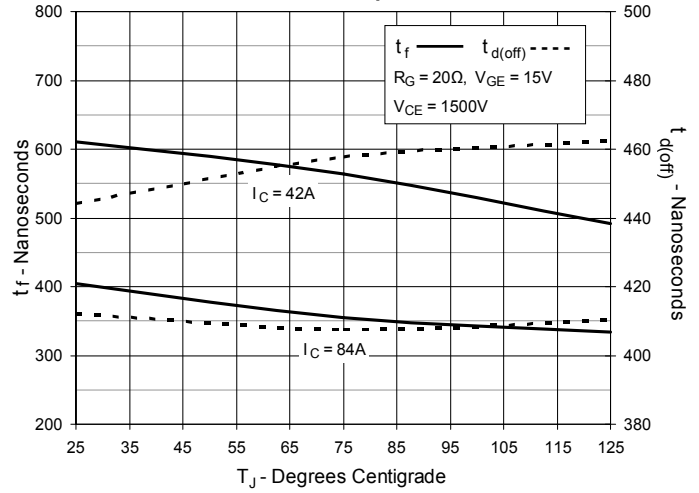

Fig. 17. Resistive Turn-off Switching Times vs. Collector Current

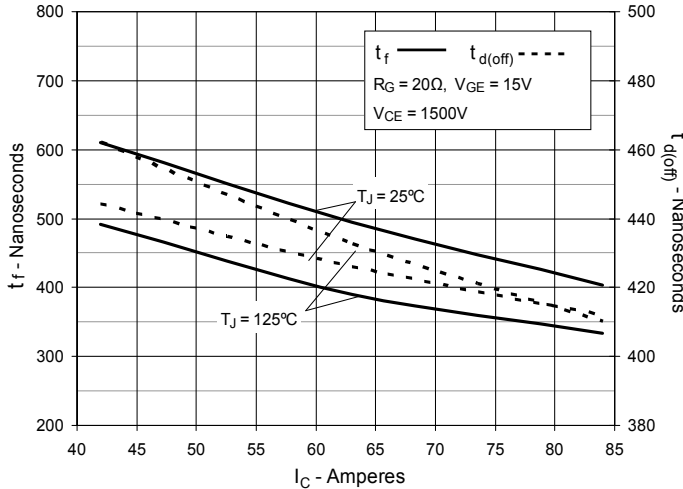

Fig. 18. Resistive Turn-off Switching Times vs. Gate Resistance

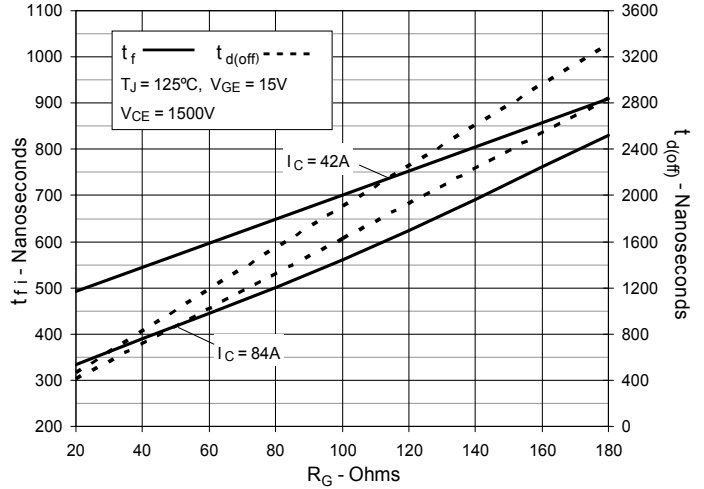

Fig. 19. Forward-Bias Safe Operating Area @ $T_C = 25^\circ\text{C}$

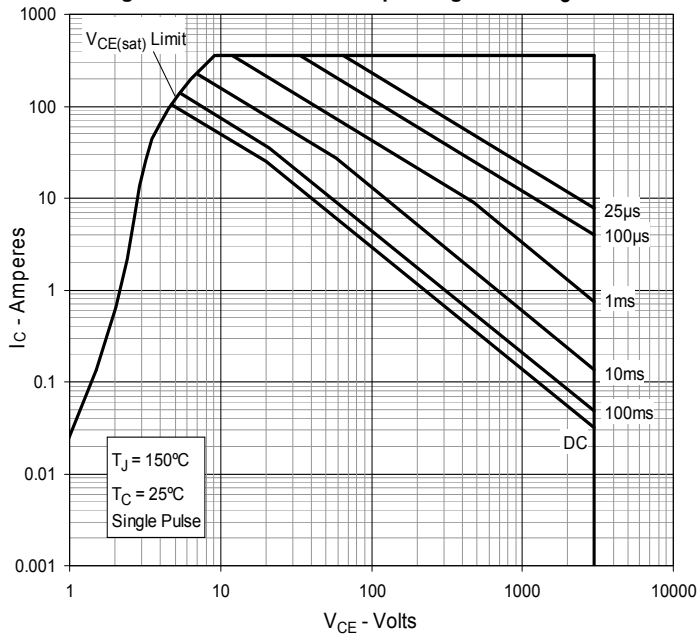
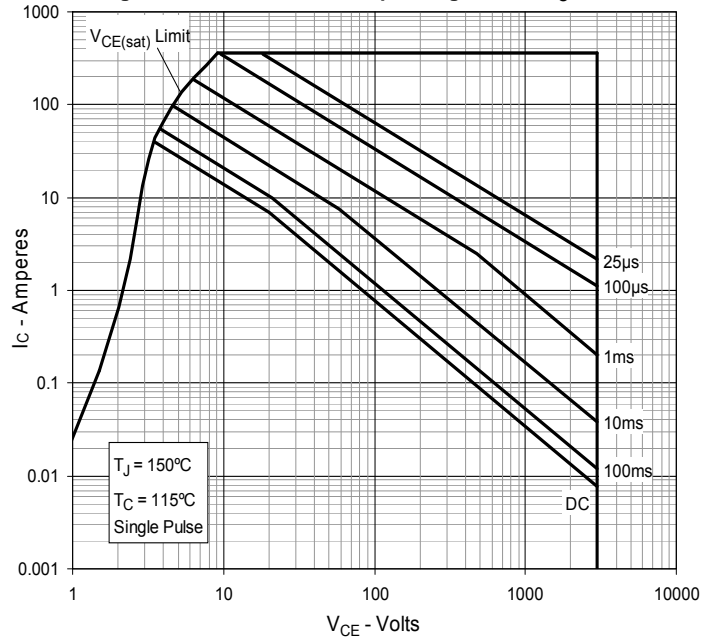

Fig. 20. Forward-Bias Safe Operating Area @ $T_C = 115^\circ\text{C}$





Disclaimer Notice - Information furnished is believed to be accurate and reliable. However, users should independently evaluate the suitability of and test each product selected for their own applications. Littelfuse products are not designed for, and may not be used in, all applications. Read complete Disclaimer Notice at www.littelfuse.com/disclaimer-electronics.