

"Schutzvermerk nach DIN ISO 16016 beachten". "Please pay attention to copyright note DIN ISO 16016".

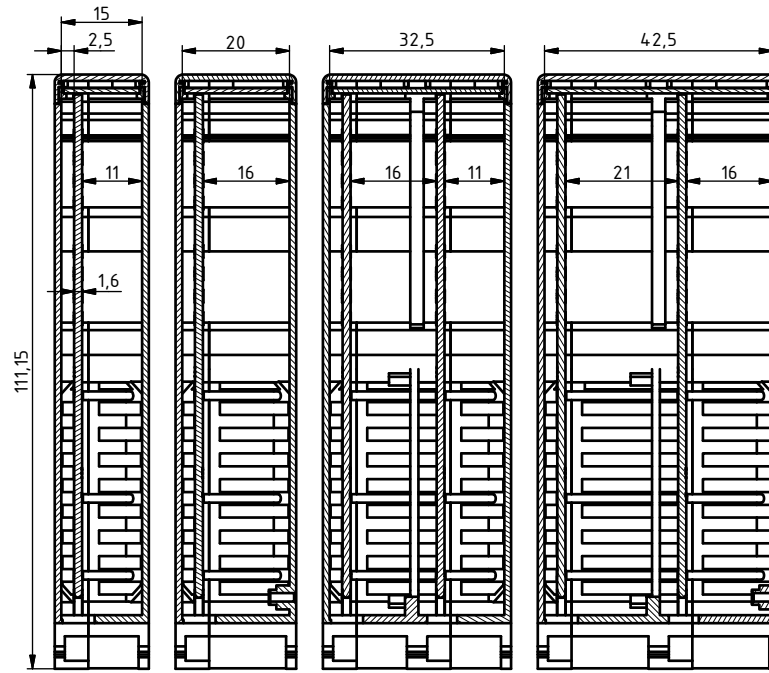

gezeichnet Ausführung mit Lüftung
pictured construction with air vents

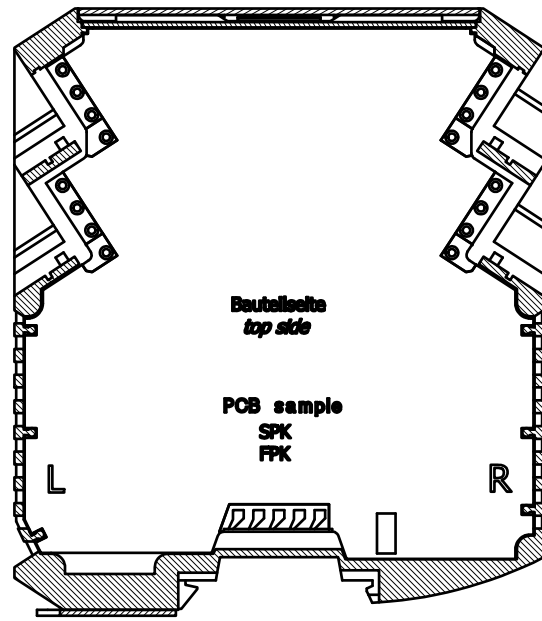
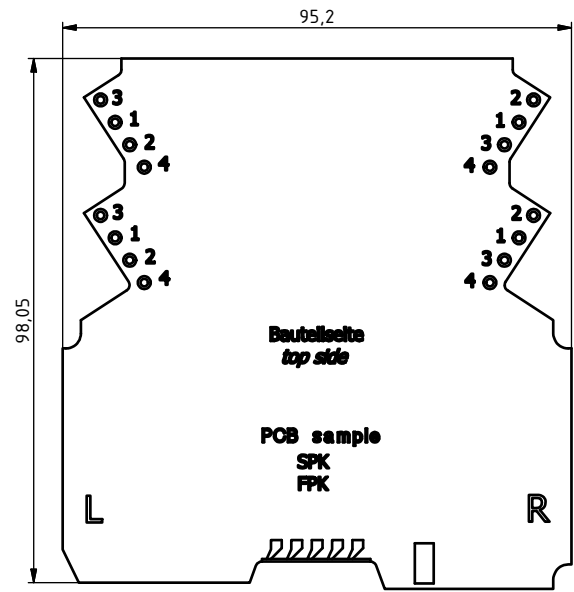
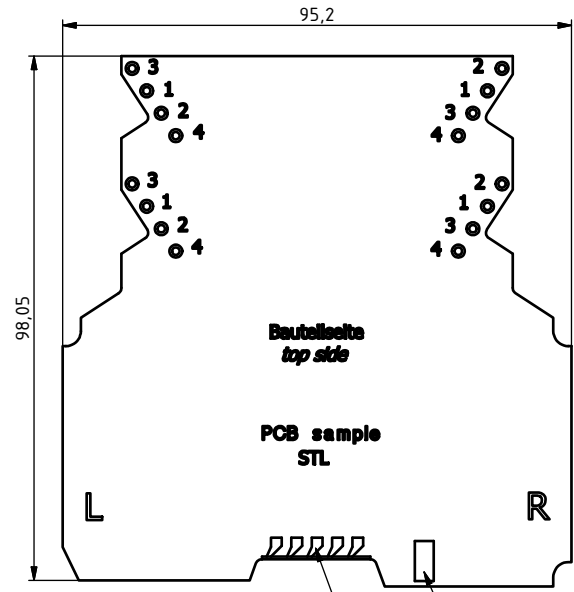
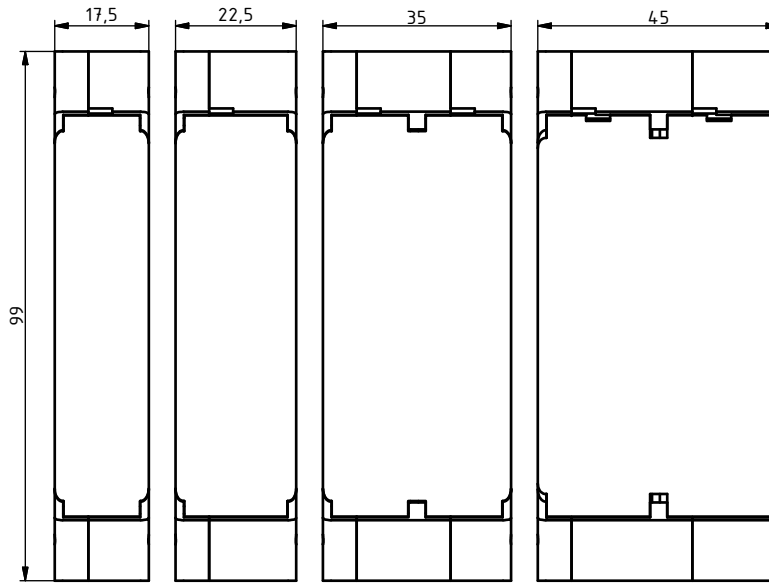

Nicht bestückbare Bereiche siehe
Klemmen/Leiterkarten-Zeichnung
restricted areas see
clamp/pcb-drawing

Kontaktfläche für PE-Kontakt
verzinkt
conductor area for PE-contact
tin-plated

Kontaktflächen für Buskontakte
vergoldet
conductor area for buscontact
gold plated

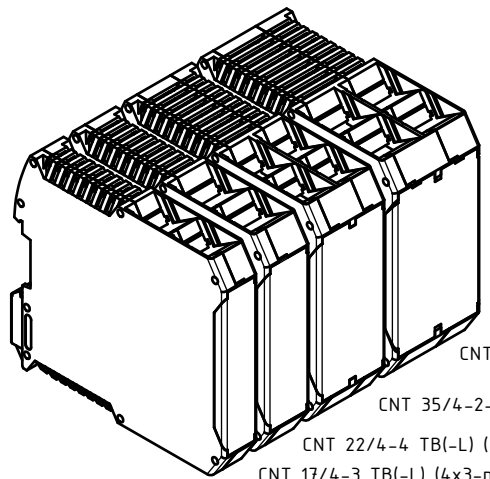

CNT 45/4-2-4 TB(-L) (8x4-polig)
CNT 35/4-2-3 TB(-L) (8x3-polig)
CNT 22/4-4 TB(-L) (4x4-polig)
CNT 17/4-3 TB(-L) (4x3-polig)

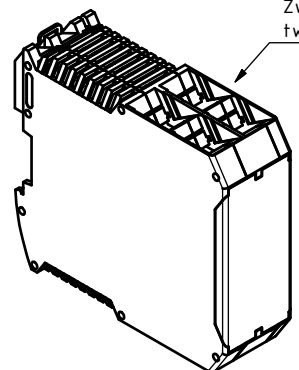

Zwei Klemmenebene beidseitig
two connecting terminal level double-sided

Maßstab/ Scale:	1:1 (1:2)	
Zeichnungs-Nr. / Drawing-No.:	2K 5400.095.02	
Artikel / Article:	CombiNorm Connect Geh. mit zwei Klemmenebenen Katalogzeichnung	
4030 A.Nr./ Alt.No.:	07.01.2013 Datum/ Date:	
DISK: 2603327.idw		A Phoenix Mecano Company
Datum/Date: 31.01.2012 HR		