

**Power-LED-Modul MinoStar  
QAUR1xx1L030**

LED-Modul für Akzent-Beleuchtungen, brillant und leistungsstark bei niedrigstem Energieverbrauch, (Kosten ca. 2,- EUR/Jahr bei 24-Std-Betrieb).

Langlebig durch temperatur-stabilisierte High-Power-LED. Mit lediglich einem Spot wird die Helligkeit einer üblichen 25W-Glühlampe erreicht.

Lieferumfang: Spot mit Anschlusslitzen (Stecker und Buchse)

Erforderliches Zubehör:

Geeignete Stromversorgung für Konstantstrom

**Power LED module MinoStar  
QAUR1xx1L030**

*LED module for accent lighting, brilliant and efficient, with very low power consumption (costs for 24-hour-operation approx. 2 €/year).*

*High durability due to temperature-stabilized high-power LED. Just one spotlight is needed to produce the same brightness as a standard 25W incandescent lamp.*

*Content of delivery: Spot with connecting wires (plug and socket)*

*Required accessories:*

*Suitable power supply for constant current*

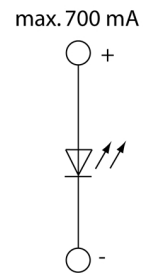
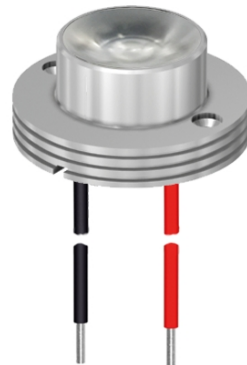
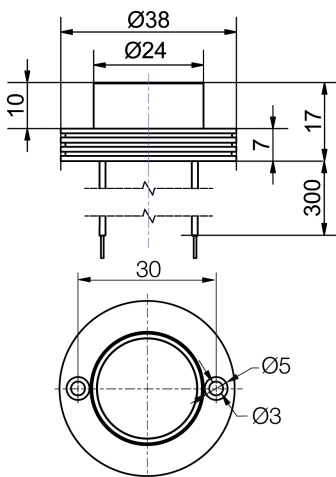

**Spezifikation**

Gehäuse: Aluminium, natur eloxiert  
 Abstrahlwinkel: wahlweise 15°, 30° oder 45°  
 Maße: Ø38mm/24mm, Länge 17mm  
 Lochabstand für Befestigung: 30mm  
 Anschluss: Litze PVC/HT 0,22mm<sup>2</sup> L=30cm  
 Farbe der Litzenisolierung: rot (+) / schwarz (-)  
 Photobiologische Sicherheit von Lampen und Lampensystemen klassifiziert nach DIN EN 62471 (für warmweiß und weiß): RG2  
 Die Spots dürfen mit jeweils max. 700mA Konstantstrom betrieben werden. Beim Anschließen mehrerer Spots an einem Netzteil niemals parallel, nur in Reihe

**Specification**





















*Housing: aluminium, natural anodized  
 Angle of radiation: 15°, 30° or 45°  
 Dimensions: Ø38mm/23.8mm, length 17mm  
 Distance between holes for attachment: 30mm  
 Connection: wire PVC/HT 0,22 mm<sup>2</sup>, L=30cm  
 Insulating colours of wires: red (+) / black (-)  
 Photobiological safety of lamps and lamp systems classified according to DIN EN 62471 (for warmwhite and white): RG2  
 The maximal constant current for the spots is 700mA.  
 Never operate the spots in the parallel connection. Use the serial connection instead.*

betreiben. Netzteil hinsichtlich seiner Leistungsdaten entsprechend der Anzahl der Spots auswählen.

*The power supply must correspond to the power consumption of the total spots quantity.*

Materialien		Material	
Teil	Material	Part	Material
Gehäuse	Aluminium eloxiert	Housing	Aluminium anodized
Optik / Linse	Acrylglas (PMMA)	Optic / lens	Acrylic glass (PMMA)
<b>Betriebstemperatur</b>	-30/+75°C	<b>Operation Temperature</b>	-30/+75°C
<b>Lagertemperatur</b>	-40/+100°C	<b>Storage Temperature</b>	-40/+100°C
Optionen		Options	
● Abweichende Anschlussmöglichkeiten		● Different connecting possibilities	

Artikel/ Part		Artikel-Text					Part-Text				
Spannung Voltage	Farbe Color	Lichtstärke Luminous Intensity	Vollwinkel Viewing Angle	Lichtstrom Luminous Flux	Leuchtdichte luminous density	Beleuchtungsstärke Illumination Level	Strom Current	Leistung Power	Lebensdauer Life-Time(1)	Anzahl LED Number of LED	
<b>QAUR1101L030</b> MinoStar rot Optik 15° Litze=30cm max. 700mA MinoStar red optic 15° wire=30cm max. 700mA											
2,2 V	● rot red		15°	51 lm			350 mA	760 mW	60000 h	1	
2,5 V	● rot red		15°	63 lm			700 mA	1.740 mW	60000 h	1	
<b>QAUR1301L030</b> MinoStar rot Optik 30° Litze=30cm max. 700mA MinoStar red optic 30° wire=30cm max. 700mA											
2,2 V	● rot red		30°	51 lm			350 mA	760 mW	60000 h	1	
2,5 V	● rot red		30°	63 lm			700 mA	1.740 mW	60000 h	1	
<b>QAUR1501L030</b> MinoStar rot Optik 45° Litze=30cm max. 700mA MinoStar red optic 45° wire=30cm max. 700mA											
2,2 V	● rot red		45°	51 lm			350 mA	760 mW	60000 h	1	
2,5 V	● rot red		45°	63 lm			700 mA	1.740 mW	60000 h	1	
<b>QAUR1121L030</b> MinoStar grün Optik 15° Litze=30cm max. 700mA MinoStar green optic 15° wire=30cm max. 700mA											
3,5 V	● grün green		15°	107 lm			350 mA	1.230 mW	60000 h	1	
3,8 V	● grün green		15°	146 lm			700 mA	2.640 mW	60000 h	1	
<b>QAUR1321L030</b> MinoStar grün Optik 30° Litze=30cm max. 700mA MinoStar green optic 30° wire=30cm max. 700mA											
3,5 V	● grün green		30°	107 lm			350 mA	1.230 mW	60000 h	1	
3,8 V	● grün green		30°	146 lm			700 mA	2.640 mW	60000 h	1	
<b>QAUR1521L030</b> MinoStar grün Optik 45° Litze=30cm max. 700mA MinoStar green optic 45° wire=30cm max. 700mA											
3,5 V	● grün green		45°	107 lm			350 mA	1.230 mW	60000 h	1	
3,8 V	● grün green		45°	146 lm			700 mA	2.640 mW	60000 h	1	
<b>QAUR1131L030</b> MinoStar orange Optik 15° Litze=30cm max. 700mA MinoStar amber optic 15° wire=30cm max. 700mA											
3,1 V	● orange amber		15°	57 lm			350 mA	1.070 mW	60000 h	1	

Artikel/ Part		Artikel-Text				Part-Text				
Spannung Voltage	Farbe Color	Lichtstärke Luminous Intensity	Vollwinkel Viewing Angle	Lichtstrom Luminous Flux	Leuchtdichte luminous intensity	Beleuchtungsstärke Illumination Level	Strom Current	Leistung Power	Lebensdauer Life-Time(L)	Anzahl LED Number of LED
3,3 V	 orange amber		15°	66 lm			700 mA	2.320 mW	60000 h	1
<b>QAUR1331L030</b>		MinoStar orange Optik 30° Litze=30cm max. 700mA				MinoStar amber optic 30° wire=30cm max. 700mA				
3,1 V	 orange amber		30°	57 lm			350 mA	1.070 mW	60000 h	1
3,3 V	 orange amber		30°	66 lm			700 mA	2.320 mW	60000 h	1
<b>QAUR1531L030</b>		MinoStar orange Optik 45° Litze=30cm max. 700mA				MinoStar amber optic 45° wire=30cm max. 700mA				
3,1 V	 orange amber		45°	57 lm			350 mA	1.070 mW	60000 h	1
3,3 V	 orange amber		45°	66 lm			700 mA	2.320 mW	60000 h	1
<b>QAUR1141L030</b>		MinoStar blau Optik 15° Litze=30cm max. 700mA				MinoStar blue optic 15° wire=30cm max. 700mA				
3,1 V	 blau blue		15°	21 lm			350 mA	1.090 mW	60000 h	1
3,4 V	 blau blue		15°	36 lm			700 mA	2.370 mW	60000 h	1
<b>QAUR1341L030</b>		MinoStar blau Optik 30° Litze=30cm max. 700mA				MinoStar blue optic 30° wire=30cm max. 700mA				
3,1 V	 blau blue		30°	21 lm			350 mA	1.090 mW	60000 h	1
3,4 V	 blau blue		30°	36 lm			700 mA	2.370 mW	60000 h	1
<b>QAUR1541L030</b>		MinoStar blau Optik 45° Litze=30cm max. 700mA				MinoStar blue optic 45° wire=30cm max. 700mA				
3,1 V	 blau blue		45°	21 lm			350 mA	1.090 mW	60000 h	1
3,4 V	 blau blue		45°	36 lm			700 mA	2.370 mW	60000 h	1
<b>QAUR1151L030</b>		MinoStar wweiß Optik 15° Litze=30cm max. 700mA				MinoStar wwwhite optic 15° wire=30cm max. 700mA				
3,2 V	 wweiß K27 wwwhite K27		15°	72 lm			350 mA	1.130 mW	60000 h	1
3,5 V	 wweiß K27 wwwhite K27		15°	104 lm			700 mA	2.420 mW	60000 h	1
<b>QAUR1351L030</b>		MinoStar wweiß Optik 30° Litze=30cm max. 700mA				MinoStar wwwhite optic 30° wire=30cm max. 700mA				
3,2 V	 wweiß K27 wwwhite K27		30°	72 lm			350 mA	1.130 mW	60000 h	1
3,5 V	 wweiß K27 wwwhite K27		30°	104 lm			700 mA	2.420 mW	60000 h	1
<b>QAUR1551L030</b>		MinoStar wweiß Optik 45° Litze=30cm max. 700mA				MinoStar wwwhite optic 45° wire=30cm max. 700mA				
3,2 V	 wweiß K27 wwwhite K27		45°	72 lm			350 mA	1.130 mW	60000 h	1
3,5 V	 wweiß K27 wwwhite K27		45°	104 lm			700 mA	2.420 mW	60000 h	1
<b>QAUR1161L030</b>		MinoStar weiß Optik 15° Litze=30cm max. 700mA				MinoStar white optic 15° wire=30cm max. 700mA				
2,9 V	 weiß K50 white K50		15°	131 lm			350 mA	1.030 mW	60000 h	1
3,1 V	 weiß K50 white K50		15°	205 lm			700 mA	2.150 mW	60000 h	1
<b>QAUR1361L030</b>		MinoStar weiß Optik 30° Litze=30cm max. 700mA				MinoStar white optic 30° wire=30cm max. 700mA				
2,9 V	 weiß K50 white K50		30°	131 lm			350 mA	1.030 mW	60000 h	1
3,1 V	 weiß K50 white K50		30°	205 lm			700 mA	2.150 mW	60000 h	1

Artikel/ Part		Artikel-Text					Part-Text				
Spannung Voltage	Farbe Color	Lichtstärke Luminous Intensity	Vollwinkel Viewing Angle	Lichtstrom Luminous Flux	Leuchtdichte luminous density	Beleuchtungsstärke Illumination Level	Strom Current	Leistung Power	Lebensdauer Life-Time(1)	Anzahl LED Number of LED	
<b>QAUR1561L030</b>		MinoStar weiß Optik 45° Litze=30cm max. 700mA					MinoStar white optic 45° wire=30cm max. 700mA				
2,9 V	Ⓢ0 weiß K50 white K50		45°	131 lm			350 mA	1.030 mW	60000 h	1	
3,1 V	Ⓢ0 weiß K50 white K50		45°	205 lm			700 mA	2.150 mW	60000 h	1	

(1) Lebensdauer bei 25° C Umgebungstemperatur

Lebensdauer: Die Lebensdauer einer LED ist definiert als Abnahme der Helligkeit auf 50% des Ausgangswertes

The life time of an LED is defined as decrease of brightness by 50% of the initial value

Technische Änderungen vorbehalten. Datenblatt unterliegt nicht dem Änderungsdienst.  
Die angegebenen technischen Daten sind typische Durchschnittswerte.

Helligkeitswerte nach CIE127 falls nicht anders angegeben.

Wir empfehlen das Dokument mit der Einstellung "Seitengröße anpassen" zu Drucken

Wir achten bei Entwicklung und Herstellung unserer Produkte auf einen möglichst geringen Einsatz von Ressourcen und auf niedrigen Energiebedarf im Betrieb.

Bitte prüfen Sie, ob es unbedingt erforderlich ist, das gesamte Dokument zu Drucken. So schonen Sie zusätzlich Ressourcen und unsere Umwelt.

*Specifications are subject to change without notice.*

*The technical data are typical figures.*

*Photometry according to CIE127 unless otherwise indicated.*

*We recommend to print the document with option "Fit to Page"*

*We care for environment when producing and manufacturing our products. Also we care for a low power consumption and a low consumption of resources.*

*Please consider environmental responsibility before printing this document*