

# MC74AC373, MC74ACT373

## Octal Transparent Latch with 3-State Outputs

The MC74AC373/74ACT373 consists of eight latches with 3-state outputs for bus organized system applications. The flip-flops appear transparent to the data when Latch Enable (LE) is HIGH. When LE is LOW, the data that meets the setup time is latched. Data appears on the bus when the Output Enable ( $\overline{OE}$ ) is LOW. When  $\overline{OE}$  is HIGH, the bus output is in the high impedance state.

### Features

- Eight Latches in a Single Package
- 3-State Outputs for Bus Interfacing
- Outputs Source/Sink 24 mA
- 'ACT373 Has TTL Compatible Inputs
- These are Pb-Free Devices

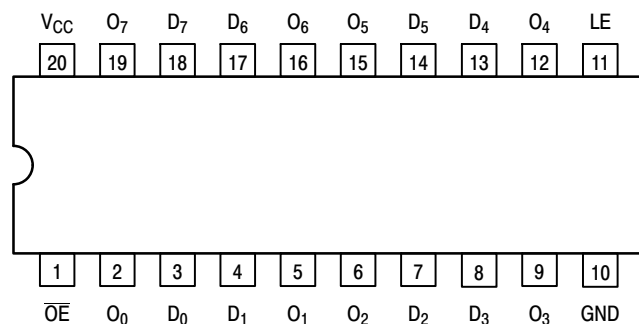

**Figure 1. Pinout: 20-Lead Packages Conductors**  
(Top View)

### PIN ASSIGNMENT

| PIN                            | FUNCTION              |
|--------------------------------|-----------------------|
| D <sub>0</sub> –D <sub>7</sub> | Data Inputs           |
| LE                             | Latch Enable Input    |
| $\overline{OE}$                | Output Enable Input   |
| O <sub>0</sub> –O <sub>7</sub> | 3-State Latch Outputs |

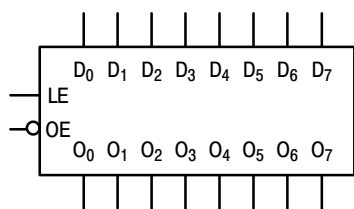
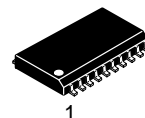

**Figure 2. Logic Symbol**



**ON Semiconductor®**

[www.onsemi.com](http://www.onsemi.com)



SOIC-20W  
DW SUFFIX  
CASE 751D

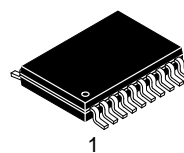

TSSOP-20  
DT SUFFIX  
CASE 948E

### ORDERING INFORMATION

See detailed ordering and shipping information in the package dimensions section on page 8 of this data sheet.

### DEVICE MARKING INFORMATION

See general marking information in the device marking section on page 9 of this data sheet.

# MC74AC373, MC74ACT373

## TRUTH TABLE

| Inputs          |    |       | Outputs |
|-----------------|----|-------|---------|
| $\overline{OE}$ | LE | $D_n$ | $O_n$   |
| H               | X  | X     | Z       |
| L               | H  | L     | L       |
| L               | H  | H     | H       |
| L               | L  | X     | $O_0$   |

H = HIGH Voltage Level

L = LOW Voltage Level

Z = High Impedance

X = Immaterial

$O_0$  = Previous  $O_0$  before LOW-to-HIGH Transition of Clock

## FUNCTIONAL DESCRIPTION

The MC74AC373/74ACT373 contains eight D-type latches with 3-state standard outputs. When the Latch Enable (LE) input is HIGH, data on the  $D_n$  inputs enters the latches. In this condition the latches are transparent, i.e., a latch output will change state each time its D input changes. When LE is LOW, the latches store the information that was present on the D inputs a setup time preceding the HIGH-to-LOW transition of LE. The 3-state standard outputs are controlled by the Output Enable ( $\overline{OE}$ ) input. When  $\overline{OE}$  is LOW, the standard outputs are in the 2-state mode. When  $\overline{OE}$  is HIGH, the standard outputs are in the high impedance mode but this does not interfere with entering new data into the latches.

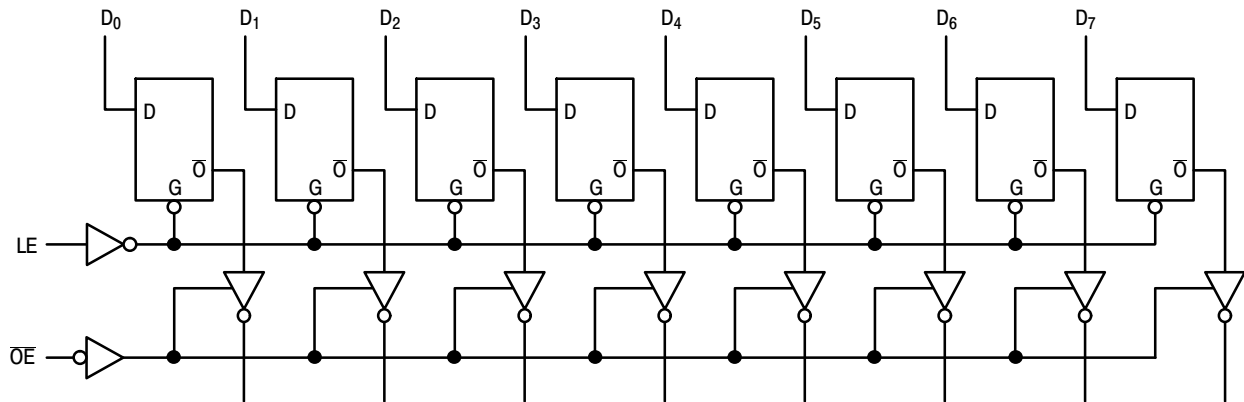

NOTE: This diagram is provided only for the understanding of logic operations and should not be used to estimate propagation delays.

Figure 3. Logic Diagram

# MC74AC373, MC74ACT373

## MAXIMUM RATINGS

| Symbol               | Parameter                                       | Value  | Unit                           |
|----------------------|---|--|--------------------------------|
| V <sub>CC</sub>      | DC Supply Voltage (Referenced to GND)           | -0.5 to +7.0   | V                              |
| V <sub>IN</sub>      | DC Input Voltage (Referenced to GND)            | -0.5 to V <sub>CC</sub> +0.5   | V                              |
| V <sub>OUT</sub>     | DC Output Voltage (Referenced to GND) (Note 1)  | -0.5 to V <sub>CC</sub> +0.5   | V                              |
| I <sub>IK</sub>      | DC Input Diode Current                          | ±20  | mA                             |
| I <sub>OK</sub>      | DC Output Diode Current                         | ±50  | mA                             |
| I <sub>OUT</sub>     | DC Output Sink/Source Current                   | ±50  | mA                             |
| I <sub>CC</sub>      | DC Supply Current, per Output Pin               | ±50  | mA                             |
| I <sub>GND</sub>     | DC Ground Current, per Output Pin               | ±100   | mA                             |
| T <sub>STG</sub>     | Storage Temperature Range                       | -65 to +150  | °C                             |
| T <sub>L</sub>       | Lead temperature, 1 mm from Case for 10 Seconds | 260  | °C                             |
| T <sub>J</sub>       | Junction Temperature Under Bias                 | 140  | °C                             |
| θ <sub>JA</sub>      | Thermal Resistance (Note 2)                     | SOIC<br>TSSOP<br>65.8<br>110.7   | °C/W                           |
| MSL                  | Moisture Sensitivity                            | SOIC<br>TSSOP<br>Level 3<br>Level 1  |                                |
| F <sub>R</sub>       | Flammability Rating                             | Oxygen Index: 30% – 35%  | UL 94 V-0 @ 0.125 in           |
| V <sub>ESD</sub>     | ESD Withstand Voltage                           | Human Body Model (Note 3)<br>Machine Model (Note 4)<br>Charged Device Model (Note 5) | > 2000<br>> 200<br>> 1000<br>V |
| I <sub>Latchup</sub> | Latchup Performance                             | Above V <sub>CC</sub> and Below GND at 85°C (Note 6)                                 | ±100<br>mA                     |

Stresses exceeding those listed in the Maximum Ratings table may damage the device. If any of these limits are exceeded, device functionality should not be assumed, damage may occur and reliability may be affected.

1. I<sub>OUT</sub> absolute maximum rating must be observed.
2. The package thermal impedance is calculated in accordance with JESD 51-7.
3. Tested to EIA/JESD22-A114-A.
4. Tested to EIA/JESD22-A115-A.
5. Tested to JESD22-C101-A.
6. Tested to EIA/JESD78.

## RECOMMENDED OPERATING CONDITIONS

| Symbol                             | Parameter   | Min                     | Typ | Max             | Unit |      |
|------------------------------------|---|-------------------------|-----|-----------------|------|------|
| V <sub>CC</sub>                    | Supply Voltage  | 'AC                     | 2.0 | 5.0             | 6.0  | V    |
|                                    |   | 'ACT                    | 4.5 | 5.0             | 5.5  |      |
| V <sub>IN</sub> , V <sub>OUT</sub> | DC Input Voltage, Output Voltage (Ref. to GND)                          | 0                       | -   | V <sub>CC</sub> | V    |      |
| t <sub>r</sub> , t <sub>f</sub>    | Input Rise and Fall Time (Note 7)<br>'AC Devices except Schmitt Inputs  | V <sub>CC</sub> @ 3.0 V | -   | 150             | -    | ns/V |
|                                    |   | V <sub>CC</sub> @ 4.5 V | -   | 40              | -    |      |
|                                    |   | V <sub>CC</sub> @ 5.5 V | -   | 25              | -    |      |
| t <sub>r</sub> , t <sub>f</sub>    | Input Rise and Fall Time (Note 8)<br>'ACT Devices except Schmitt Inputs | V <sub>CC</sub> @ 4.5 V | -   | 10              | -    | ns/V |
|                                    |   | V <sub>CC</sub> @ 5.5 V | -   | 8.0             | -    |      |
| T <sub>A</sub>                     | Operating Ambient Temperature Range                                     | -40                     | 25  | 85              | °C   |      |
| I <sub>OH</sub>                    | Output Current – High   | -                       | -   | -24             | mA   |      |
| I <sub>OL</sub>                    | Output Current – Low  | -                       | -   | 24              | mA   |      |

Functional operation above the stresses listed in the Recommended Operating Ranges is not implied. Extended exposure to stresses beyond the Recommended Operating Ranges limits may affect device reliability.

7. V<sub>IN</sub> from 30% to 70% V<sub>CC</sub>; see individual Data Sheets for devices that differ from the typical input rise and fall times.
8. V<sub>IN</sub> from 0.8 V to 2.0 V; see individual Data Sheets for devices that differ from the typical input rise and fall times.

# MC74AC373, MC74ACT373

## DC CHARACTERISTICS

| Symbol           | Parameter                            | V <sub>CC</sub><br>(V) | 74AC                   |                   | 74AC                               |  | Unit | Conditions  |
|------------------|--------------------------------------|------------------------|------------------------|-------------------|------------------------------------|--|------|---|
|                  |                                      |                        | T <sub>A</sub> = +25°C |                   | T <sub>A</sub> =<br>-40°C to +85°C |  |      |   |
|                  |                                      |                        | Typ                    | Guaranteed Limits |                                    |  |      |   |
| V <sub>IH</sub>  | Minimum High Level<br>Input Voltage  | 3.0                    | 1.5                    | 2.1               | 2.1                                |  | V    | V <sub>OUT</sub> = 0.1 V<br>or V <sub>CC</sub> - 0.1 V  |
|                  |                                      | 4.5                    | 2.25                   | 3.15              | 3.15                               |  |      |   |
|                  |                                      | 5.5                    | 2.75                   | 3.85              | 3.85                               |  |      |   |
| V <sub>IL</sub>  | Maximum Low Level<br>Input Voltage   | 3.0                    | 1.5                    | 0.9               | 0.9                                |  | V    | V <sub>OUT</sub> = 0.1 V<br>or V <sub>CC</sub> - 0.1 V  |
|                  |                                      | 4.5                    | 2.25                   | 1.35              | 1.35                               |  |      |   |
|                  |                                      | 5.5                    | 2.75                   | 1.65              | 1.65                               |  |      |   |
| V <sub>OH</sub>  | Minimum High Level<br>Output Voltage | 3.0                    | 2.99                   | 2.9               | 2.9                                |  | V    | I <sub>OUT</sub> = -50 μA   |
|                  |                                      | 4.5                    | 4.49                   | 4.4               | 4.4                                |  |      |   |
|                  |                                      | 5.5                    | 5.49                   | 5.4               | 5.4                                |  |      |   |
|                  |                                      | 3.0                    | -                      | 2.56              | 2.46                               |  | V    | *V <sub>IN</sub> = V <sub>IL</sub> or V <sub>IH</sub><br>-12 mA<br>I <sub>OH</sub> -24 mA<br>-24 mA   |
|                  |                                      | 4.5                    | -                      | 3.86              | 3.76                               |  |      |   |
|                  |                                      | 5.5                    | -                      | 4.86              | 4.76                               |  |      |   |
| V <sub>OL</sub>  | Maximum Low Level<br>Output Voltage  | 3.0                    | 0.002                  | 0.1               | 0.1                                |  | V    | I <sub>OUT</sub> = 50 μA  |
|                  |                                      | 4.5                    | 0.001                  | 0.1               | 0.1                                |  |      |   |
|                  |                                      | 5.5                    | 0.001                  | 0.1               | 0.1                                |  |      |   |
|                  |                                      | 3.0                    | -                      | 0.36              | 0.44                               |  | V    | *V <sub>IN</sub> = V <sub>IL</sub> or V <sub>IH</sub><br>12 mA<br>I <sub>OL</sub> 24 mA<br>24 mA  |
|                  |                                      | 4.5                    | -                      | 0.36              | 0.44                               |  |      |   |
|                  |                                      | 5.5                    | -                      | 0.36              | 0.44                               |  |      |   |
| I <sub>IN</sub>  | Maximum Input<br>Leakage Current     | 5.5                    | -                      | ±0.1              | ±1.0                               |  | μA   | V <sub>I</sub> = V <sub>CC</sub> , GND  |
| I <sub>OZ</sub>  | Maximum<br>3-State<br>Current        | 5.5                    | -                      | ±0.5              | ±5.0                               |  | μA   | V <sub>I</sub> (OE) = V <sub>IL</sub> , V <sub>IH</sub><br>V <sub>I</sub> = V <sub>CC</sub> , GND<br>V <sub>O</sub> = V <sub>CC</sub> , GND |
| I <sub>OLD</sub> | †Minimum Dynamic<br>Output Current   | 5.5                    | -                      | -                 | 75                                 |  | mA   | V <sub>OLD</sub> = 1.65 V<br>Max  |
| I <sub>OHD</sub> |                                      | 5.5                    | -                      | -                 | -75                                |  | mA   | V <sub>OHD</sub> = 3.85 V Min   |
| I <sub>CC</sub>  | Maximum Quiescent<br>Supply Current  | 5.5                    | -                      | 8.0               | 80                                 |  | μA   | V <sub>IN</sub> = V <sub>CC</sub> or GND  |

Product parametric performance is indicated in the Electrical Characteristics for the listed test conditions, unless otherwise noted. Product performance may not be indicated by the Electrical Characteristics if operated under different conditions.

\*All outputs loaded; thresholds on input associated with output under test.

†Maximum test duration 2.0 ms, one output loaded at a time.

NOTE: I<sub>IN</sub> and I<sub>CC</sub> @ 3.0 V are guaranteed to be less than or equal to the respective limit @ 5.5 V V<sub>CC</sub>.

# MC74AC373, MC74ACT373

## AC CHARACTERISTICS (For Figures and Waveforms – See AND8277/D at www.onsemi.com)

| Symbol           | Parameter   | V <sub>CC</sub> *<br>(V) | 74AC   |            |             | 74AC   |              | Unit | Fig. No. |
|------------------|---|--------------------------|--|------------|-------------|--|--------------|------|----------|
|                  |   |                          | T <sub>A</sub> = +25°C<br>C <sub>L</sub> = 50 pF |            |             | T <sub>A</sub> = -40°C<br>to +85°C<br>C <sub>L</sub> = 50 pF |              |      |          |
|                  |   |                          | Min  | Typ        | Max         | Min  | Max          |      |          |
| t <sub>PLH</sub> | Propagation Delay<br>D <sub>n</sub> to O <sub>n</sub> | 3.3<br>5.0               | 1.5<br>1.5                                       | 10<br>7.0  | 13.5<br>9.5 | 1.5<br>1.5   | 15<br>10.5   | ns   | 3-5      |
| t <sub>PHL</sub> | Propagation Delay<br>D <sub>n</sub> to O <sub>n</sub> | 3.3<br>5.0               | 1.5<br>1.5                                       | 9.5<br>7.0 | 13<br>9.5   | 1.5<br>1.5   | 14.5<br>10.5 | ns   | 3-5      |
| t <sub>PLH</sub> | Propagation Delay<br>LE to O <sub>n</sub>             | 3.3<br>5.0               | 1.5<br>1.5                                       | 10<br>7.5  | 13.5<br>9.5 | 1.5<br>1.5   | 15<br>10.5   | ns   | 3-6      |
| t <sub>PHL</sub> | Propagation Delay<br>LE to O <sub>n</sub>             | 3.3<br>5.0               | 1.5<br>1.5                                       | 9.5<br>7.0 | 12.5<br>9.5 | 1.5<br>1.5   | 14<br>10.5   | ns   | 3-6      |
| t <sub>PZH</sub> | Output Enable Time                                    | 3.3<br>5.0               | 1.5<br>1.5                                       | 9.0<br>7.0 | 11.5<br>8.5 | 1.0<br>1.0   | 13<br>9.5    | ns   | 3-7      |
| t <sub>PZL</sub> | Output Enable Time                                    | 3.3<br>5.0               | 1.5<br>1.5                                       | 8.5<br>6.5 | 11.5<br>8.5 | 1.0<br>1.0   | 13<br>9.5    | ns   | 3-8      |
| t <sub>PHZ</sub> | Output Disable Time                                   | 3.3<br>5.0               | 1.5<br>1.5                                       | 10<br>8.0  | 12.5<br>11  | 1.0<br>1.0   | 14.5<br>12.5 | ns   | 3-7      |
| t <sub>PLZ</sub> | Output Disable Time                                   | 3.3<br>5.0               | 1.5<br>1.5                                       | 8.0<br>6.5 | 11.5<br>8.5 | 1.0<br>1.0   | 12.5<br>10   | ns   | 3-8      |

\*Voltage Range 3.3 V is 3.3 V ±0.3 V.  
Voltage Range 5.0 V is 5.0 V ±0.5 V.

## AC OPERATING REQUIREMENTS

| Symbol         | Parameter                                       | V <sub>CC</sub> *<br>(V) | 74AC   |                    | 74AC   |  | Unit | Fig. No. |
|----------------|---|--------------------------|--|--------------------|--|--|------|----------|
|                |   |                          | T <sub>A</sub> = +25°C<br>C <sub>L</sub> = 50 pF |                    | T <sub>A</sub> = -40°C<br>to +85°C<br>C <sub>L</sub> = 50 pF |  |      |          |
|                |   |                          | Typ  | Guaranteed Minimum |  |  |      |          |
| t <sub>s</sub> | Setup Time, HIGH or LOW<br>D <sub>n</sub> to LE | 3.3<br>5.0               | 3.5<br>2.0                                       | 5.5<br>4.0         | 6.0<br>4.5   |  | ns   | 3-9      |
| t <sub>h</sub> | Hold Time, HIGH or LOW<br>D <sub>n</sub> to LE  | 3.3<br>5.0               | -3.0<br>-1.5                                     | 1.0<br>1.0         | 1.0<br>1.0   |  | ns   | 3-9      |
| t <sub>w</sub> | LE Pulse Width, HIGH                            | 3.3<br>5.0               | 4.0<br>2.0                                       | 5.5<br>4.0         | 6.0<br>4.5   |  | ns   | 3-6      |

\*Voltage Range 3.3 V is 3.3 V ±0.3 V.  
Voltage Range 5.0 V is 5.0 V ±0.5 V.

# MC74AC373, MC74ACT373

## DC CHARACTERISTICS

| Symbol            | Parameter                              | V <sub>CC</sub><br>(V) | 74ACT                  |                   | 74ACT                              |    | Unit  | Conditions |
|-------------------|--|------------------------|------------------------|-------------------|------------------------------------|----|---|------------|
|                   |  |                        | T <sub>A</sub> = +25°C |                   | T <sub>A</sub> =<br>-40°C to +85°C |    |   |            |
|                   |  |                        | Typ                    | Guaranteed Limits |                                    |    |   |            |
| V <sub>IH</sub>   | Minimum High Level Input Voltage       | 4.5                    | 1.5                    | 2.0               | 2.0                                | V  | V <sub>OUT</sub> = 0.1 V<br>or V <sub>CC</sub> - 0.1 V  |            |
|                   |  | 5.5                    | 1.5                    | 2.0               | 2.0                                |    |   |            |
| V <sub>IL</sub>   | Maximum Low Level Input Voltage        | 4.5                    | 1.5                    | 0.8               | 0.8                                | V  | V <sub>OUT</sub> = 0.1 V<br>or V <sub>CC</sub> - 0.1 V  |            |
|                   |  | 5.5                    | 1.5                    | 0.8               | 0.8                                |    |   |            |
| V <sub>OH</sub>   | Minimum High Level Output Voltage      | 4.5                    | 4.49                   | 4.4               | 4.4                                | V  | I <sub>OUT</sub> = -50 μA   |            |
|                   |  | 5.5                    | 5.49                   | 5.4               | 5.4                                |    |   |            |
|                   |  | 4.5                    | -                      | 3.86              | 3.76                               | V  | *V <sub>IN</sub> = V <sub>IL</sub> or V <sub>IH</sub><br>I <sub>OH</sub> -24 mA<br>-24 mA   |            |
| V <sub>OL</sub>   | Maximum Low Level Output Voltage       | 4.5                    | 0.001                  | 0.1               | 0.1                                | V  | I <sub>OUT</sub> = 50 μA  |            |
|                   |  | 5.5                    | 0.001                  | 0.1               | 0.1                                |    |   |            |
| V <sub>OL</sub>   | Maximum Low Level Output Voltage       | 4.5                    | -                      | 0.36              | 0.44                               | V  | *V <sub>IN</sub> = V <sub>IL</sub> or V <sub>IH</sub><br>24 mA<br>I <sub>OL</sub> 24 mA   |            |
|                   |  | 5.5                    | -                      | 0.36              | 0.44                               |    |   |            |
| I <sub>IN</sub>   | Maximum Input Leakage Current          | 5.5                    | -                      | ±0.1              | ±1.0                               | μA | V <sub>I</sub> = V <sub>CC</sub> , GND  |            |
| ΔI <sub>CCT</sub> | Additional Max. I <sub>CC</sub> /Input | 5.5                    | 0.6                    | -                 | 1.5                                | mA | V <sub>I</sub> = V <sub>CC</sub> - 2.1 V  |            |
| I <sub>OZ</sub>   | Maximum 3-State Current                | 5.5                    | -                      | ±0.5              | ±5.0                               | μA | V <sub>I</sub> (OE) = V <sub>IL</sub> , V <sub>IH</sub><br>V <sub>I</sub> = V <sub>CC</sub> , GND<br>V <sub>O</sub> = V <sub>CC</sub> , GND |            |
| I <sub>OLD</sub>  | †Minimum Dynamic Output Current        | 5.5                    | -                      | -                 | 75                                 | mA | V <sub>OLD</sub> = 1.65 V Max   |            |
| I <sub>OHD</sub>  |  | 5.5                    | -                      | -                 | -75                                | mA | V <sub>OHD</sub> = 3.85 V Min   |            |
| I <sub>CC</sub>   | Maximum Quiescent Supply Current       | 5.5                    | -                      | 8.0               | 80                                 | μA | V <sub>IN</sub> = V <sub>CC</sub> or GND  |            |

\*All outputs loaded; thresholds on input associated with output under test.

†Maximum test duration 2.0 ms, one output loaded at a time.

# MC74AC373, MC74ACT373

**AC CHARACTERISTICS** (For Figures and Waveforms – See AND8277/D at [www.onsemi.com](http://www.onsemi.com))

| Symbol           | Parameter   | V <sub>CC</sub> *<br>(V) | 74ACT  |     |     | 74ACT  |      | Unit | Fig. No. |
|------------------|---|--------------------------|--|-----|-----|--|------|------|----------|
|                  |   |                          | T <sub>A</sub> = +25°C<br>C <sub>L</sub> = 50 pF |     |     | T <sub>A</sub> = -40°C<br>to +85°C<br>C <sub>L</sub> = 50 pF |      |      |          |
|                  |   |                          | Min  | Typ | Max | Min  | Max  |      |          |
| t <sub>PLH</sub> | Propagation Delay<br>D <sub>n</sub> to O <sub>n</sub> | 5.0                      | 2.5  | 8.5 | 10  | 1.5  | 11.5 | ns   | 3-5      |
| t <sub>PHL</sub> | Propagation Delay<br>D <sub>n</sub> to O <sub>n</sub> | 5.0                      | 2.0  | 8.0 | 10  | 1.5  | 11.5 | ns   | 3-5      |
| t <sub>PLH</sub> | Propagation Delay<br>LE to O <sub>n</sub>             | 5.0                      | 2.5  | 8.5 | 11  | 2.0  | 11.5 | ns   | 3-6      |
| t <sub>PHL</sub> | Propagation Delay<br>LE to O <sub>n</sub>             | 5.0                      | 2.0  | 8.0 | 10  | 1.5  | 11.5 | ns   | 3-6      |
| t <sub>PZH</sub> | Output Enable Time                                    | 5.0                      | 2.0  | 8.0 | 9.5 | 1.5  | 10.5 | ns   | 3-7      |
| t <sub>PZL</sub> | Output Enable Time                                    | 5.0                      | 2.0  | 7.5 | 9.0 | 1.5  | 10.5 | ns   | 3-8      |
| t <sub>PHZ</sub> | Output Disable Time                                   | 5.0                      | 2.5  | 9.0 | 11  | 2.5  | 12.5 | ns   | 3-7      |
| t <sub>PLZ</sub> | Output Disable Time                                   | 5.0                      | 1.5  | 7.5 | 8.5 | 1.0  | 10   | ns   | 3-8      |

\*Voltage Range 5.0 V is 5.0 V ±0.5 V.

**AC OPERATING REQUIREMENTS** (For Figures and Waveforms – See AND8277/D at [www.onsemi.com](http://www.onsemi.com))

| Symbol         | Parameter                                       | V <sub>CC</sub> *<br>(V) | 74ACT  |                    | 74ACT  |    | Unit | Fig. No. |
|----------------|---|--------------------------|--|--------------------|--|----|------|----------|
|                |   |                          | T <sub>A</sub> = +25°C<br>C <sub>L</sub> = 50 pF |                    | T <sub>A</sub> = -40°C<br>to +85°C<br>C <sub>L</sub> = 50 pF |    |      |          |
|                |   |                          | Typ  | Guaranteed Minimum |  |    |      |          |
| t <sub>s</sub> | Setup Time, HIGH or LOW<br>D <sub>n</sub> to LE | 5.0                      | 3.0  | 7.0                | 8.0  | ns | 3-9  |          |
| t <sub>h</sub> | Hold Time, HIGH or LOW<br>D <sub>n</sub> to LE  | 5.0                      | 0  | 0                  | 1.0  | ns | 3-9  |          |
| t <sub>w</sub> | LE Pulse Width, HIGH                            | 5.0                      | 2.0  | 7.0                | 8.0  | ns | 3-6  |          |

\*Voltage Range 5.0 V is 5.0 V ±0.5 V.

## CAPACITANCE

| Symbol          | Parameter                     | Value<br>Typ | Unit | Test Conditions         |
|-----------------|-------------------------------|--------------|------|-------------------------|
| C <sub>IN</sub> | Input Capacitance             | 4.5          | pF   | V <sub>CC</sub> = 5.0 V |
| C <sub>PD</sub> | Power Dissipation Capacitance | 40           | pF   | V <sub>CC</sub> = 5.0 V |

# MC74AC373, MC74ACT373

## ORDERING INFORMATION

| Device          | Package               | Shipping†          |
|-----------------|-----------------------|--------------------|
| MC74AC373DWG    | SOIC-20<br>(Pb-Free)  | 38 Units / Rail    |
| MC74AC373DWR2G  | SOIC-20<br>(Pb-Free)  | 1000 / Tape & Reel |
| MC74ACT373DWG   | SOIC-20<br>(Pb-Free)  | 38 Units / Rail    |
| MC74ACT373DWR2G | SOIC-20<br>(Pb-Free)  | 1000 / Tape & Reel |
| MC74AC373DTG    | TSSOP-20<br>(Pb-Free) | 75 Units / Rail    |
| MC74AC373DTR2G  | TSSOP-20<br>(Pb-Free) | 2500 / Tape & Reel |
| MC74ACT373DTG   | TSSOP-20<br>(Pb-Free) | 75 Units / Rail    |
| MC74ACT373DTR2G | TSSOP-20<br>(Pb-Free) | 2500 / Tape & Reel |

†For information on tape and reel specifications, including part orientation and tape sizes, please refer to our Tape and Reel Packaging Specifications Brochure, BRD8011/D.

## MARKING DIAGRAMS

SOIC-20W

TSSOP-20

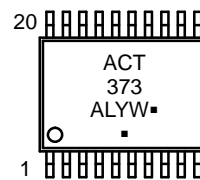
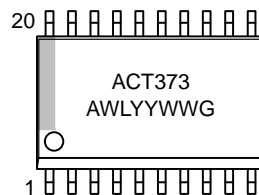
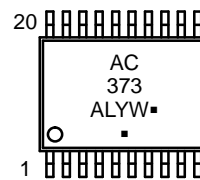
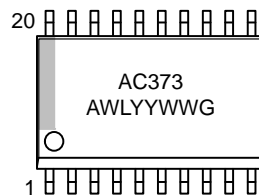

A = Assembly Location  
 WL, L = Wafer Lot  
 YY, Y = Year  
 WW, W = Work Week  
 G or ▪ = Pb-Free Package  
 (Note: Microdot may be in either location)



# MECHANICAL CASE OUTLINE PACKAGE DIMENSIONS



SCALE 1:1

SOIC-20 WB  
CASE 751D-05  
ISSUE H

DATE 22 APR 2015



NOTES:

1. DIMENSIONS ARE IN MILLIMETERS.
2. INTERPRET DIMENSIONS AND TOLERANCES PER ASME Y14.5M, 1994.
3. DIMENSIONS D AND E DO NOT INCLUDE MOLD PROTRUSION.
4. MAXIMUM MOLD PROTRUSION 0.15 PER SIDE.
5. DIMENSION B DOES NOT INCLUDE DAMBAR PROTRUSION. ALLOWABLE PROTRUSION SHALL BE 0.13 TOTAL IN EXCESS OF B DIMENSION AT MAXIMUM MATERIAL CONDITION.

| DIM | MILLIMETERS |       |
|-----|-------------|-------|
|     | MIN         | MAX   |
| A   | 2.35        | 2.65  |
| A1  | 0.10        | 0.25  |
| b   | 0.35        | 0.49  |
| c   | 0.23        | 0.32  |
| D   | 12.65       | 12.95 |
| E   | 7.40        | 7.60  |
| e   | 1.27 BSC    |       |
| H   | 10.05       | 10.55 |
| h   | 0.25        | 0.75  |
| L   | 0.50        | 0.90  |
| θ   | 0°          | 7°    |

RECOMMENDED  
SOLDERING FOOTPRINT\*



DIMENSIONS: MILLIMETERS

\*For additional information on our Pb-Free strategy and soldering details, please download the ON Semiconductor Soldering and Mounting Techniques Reference Manual, SOLDERRM/D.

GENERIC  
MARKING DIAGRAM\*



- XXXXXX = Specific Device Code
- A = Assembly Location
- WL = Wafer Lot
- YY = Year
- WW = Work Week
- G = Pb-Free Package

\*This information is generic. Please refer to device data sheet for actual part marking. Pb-Free indicator, "G" or microdot "▪", may or may not be present. Some products may not follow the Generic Marking.

|                  |             |  |
|------------------|-------------|--|
| DOCUMENT NUMBER: | 98ASB42343B | Electronic versions are uncontrolled except when accessed directly from the Document Repository. Printed versions are uncontrolled except when stamped "CONTROLLED COPY" in red. |
| DESCRIPTION:     | SOIC-20 WB  | PAGE 1 OF 1  |

onsemi and ONSEMI are trademarks of Semiconductor Components Industries, LLC dba onsemi or its subsidiaries in the United States and/or other countries. onsemi reserves the right to make changes without further notice to any products herein. onsemi makes no warranty, representation or guarantee regarding the suitability of its products for any particular purpose, nor does onsemi assume any liability arising out of the application or use of any product or circuit, and specifically disclaims any and all liability, including without limitation special, consequential or incidental damages. onsemi does not convey any license under its patent rights nor the rights of others.

# MECHANICAL CASE OUTLINE

## PACKAGE DIMENSIONS

ON Semiconductor®



TSSOP-20 WB  
CASE 948E  
ISSUE D

DATE 17 FEB 2016

SCALE 2:1



NOTES:

1. DIMENSIONING AND TOLERANCING PER ANSI Y14.5M, 1982.
2. CONTROLLING DIMENSION: MILLIMETER.
3. DIMENSION A DOES NOT INCLUDE MOLD FLASH, PROTRUSIONS OR GATE BURRS. MOLD FLASH OR GATE BURRS SHALL NOT EXCEED 0.15 (0.006) PER SIDE.
4. DIMENSION B DOES NOT INCLUDE INTERLEAD FLASH OR PROTRUSION. INTERLEAD FLASH OR PROTRUSION SHALL NOT EXCEED 0.25 (0.010) PER SIDE.
5. DIMENSION K DOES NOT INCLUDE DAMBAR PROTRUSION. ALLOWABLE DAMBAR PROTRUSION SHALL BE 0.08 (0.003) TOTAL IN EXCESS OF THE K DIMENSION AT MAXIMUM MATERIAL CONDITION.
6. TERMINAL NUMBERS ARE SHOWN FOR REFERENCE ONLY.
7. DIMENSION A AND B ARE TO BE DETERMINED AT DATUM PLANE -W-.

| DIM | MILLIMETERS |      | INCHES    |       |
|-----|-------------|------|-----------|-------|
|     | MIN         | MAX  | MIN       | MAX   |
| A   | 6.40        | 6.60 | 0.252     | 0.260 |
| B   | 4.30        | 4.50 | 0.169     | 0.177 |
| C   | ---         | 1.20 | ---       | 0.047 |
| D   | 0.05        | 0.15 | 0.002     | 0.006 |
| F   | 0.50        | 0.75 | 0.020     | 0.030 |
| G   | 0.65 BSC    |      | 0.026 BSC |       |
| H   | 0.27        | 0.37 | 0.011     | 0.015 |
| J   | 0.09        | 0.20 | 0.004     | 0.008 |
| J1  | 0.09        | 0.16 | 0.004     | 0.006 |
| K   | 0.19        | 0.30 | 0.007     | 0.012 |
| K1  | 0.19        | 0.25 | 0.007     | 0.010 |
| L   | 6.40 BSC    |      | 0.252 BSC |       |
| M   | 0°          | 8°   | 0°        | 8°    |



SOLDERING FOOTPRINT



GENERIC MARKING DIAGRAM\*



- A = Assembly Location
- L = Wafer Lot
- Y = Year
- W = Work Week
- = Pb-Free Package

(Note: Microdot may be in either location)

\*This information is generic. Please refer to device data sheet for actual part marking. Pb-Free indicator, "G" or microdot "▪", may or may not be present.

|                  |             |  |
|------------------|-------------|--|
| DOCUMENT NUMBER: | 98ASH70169A | Electronic versions are uncontrolled except when accessed directly from the Document Repository. Printed versions are uncontrolled except when stamped "CONTROLLED COPY" in red. |
| DESCRIPTION:     | TSSOP-20 WB | PAGE 1 OF 1  |

ON Semiconductor and ON are trademarks of Semiconductor Components Industries, LLC dba ON Semiconductor or its subsidiaries in the United States and/or other countries. ON Semiconductor reserves the right to make changes without further notice to any products herein. ON Semiconductor makes no warranty, representation or guarantee regarding the suitability of its products for any particular purpose, nor does ON Semiconductor assume any liability arising out of the application or use of any product or circuit, and specifically disclaims any and all liability, including without limitation special, consequential or incidental damages. ON Semiconductor does not convey any license under its patent rights nor the rights of others.

**onsemi**, **Onsemi**, and other names, marks, and brands are registered and/or common law trademarks of Semiconductor Components Industries, LLC dba "**onsemi**" or its affiliates and/or subsidiaries in the United States and/or other countries. **onsemi** owns the rights to a number of patents, trademarks, copyrights, trade secrets, and other intellectual property. A listing of **onsemi**'s product/patent coverage may be accessed at [www.onsemi.com/site/pdf/Patent-Marking.pdf](http://www.onsemi.com/site/pdf/Patent-Marking.pdf). **onsemi** reserves the right to make changes at any time to any products or information herein, without notice. The information herein is provided "as-is" and **onsemi** makes no warranty, representation or guarantee regarding the accuracy of the information, product features, availability, functionality, or suitability of its products for any particular purpose, nor does **onsemi** assume any liability arising out of the application or use of any product or circuit, and specifically disclaims any and all liability, including without limitation special, consequential or incidental damages. Buyer is responsible for its products and applications using **onsemi** products, including compliance with all laws, regulations and safety requirements or standards, regardless of any support or applications information provided by **onsemi**. "Typical" parameters which may be provided in **onsemi** data sheets and/or specifications can and do vary in different applications and actual performance may vary over time. All operating parameters, including "Typicals" must be validated for each customer application by customer's technical experts. **onsemi** does not convey any license under any of its intellectual property rights nor the rights of others. **onsemi** products are not designed, intended, or authorized for use as a critical component in life support systems or any FDA Class 3 medical devices or medical devices with a same or similar classification in a foreign jurisdiction or any devices intended for implantation in the human body. Should Buyer purchase or use **onsemi** products for any such unintended or unauthorized application, Buyer shall indemnify and hold **onsemi** and its officers, employees, subsidiaries, affiliates, and distributors harmless against all claims, costs, damages, and expenses, and reasonable attorney fees arising out of, directly or indirectly, any claim of personal injury or death associated with such unintended or unauthorized use, even if such claim alleges that **onsemi** was negligent regarding the design or manufacture of the part. **onsemi** is an Equal Opportunity/Affirmative Action Employer. This literature is subject to all applicable copyright laws and is not for resale in any manner.

## PUBLICATION ORDERING INFORMATION

### LITERATURE FULFILLMENT:

Email Requests to: [orderlit@onsemi.com](mailto:orderlit@onsemi.com)

**onsemi Website:** [www.onsemi.com](http://www.onsemi.com)

### TECHNICAL SUPPORT

**North American Technical Support:**

Voice Mail: 1 800-282-9855 Toll Free USA/Canada

Phone: 011 421 33 790 2910

**Europe, Middle East and Africa Technical Support:**

Phone: 00421 33 790 2910

For additional information, please contact your local Sales Representative