

■ Features

- High Luminous LEDs
- 10mm Round Standard Directivity
- UV Resistant Epoxy
- Water Clear Type

■ Applications

- Backlighting (Illuminated advertising, general lighting, etc)
- Interior and exterior automotive lighting
- Traffic signaling / Beacons
- Other Lighting

■ Outline Dimension

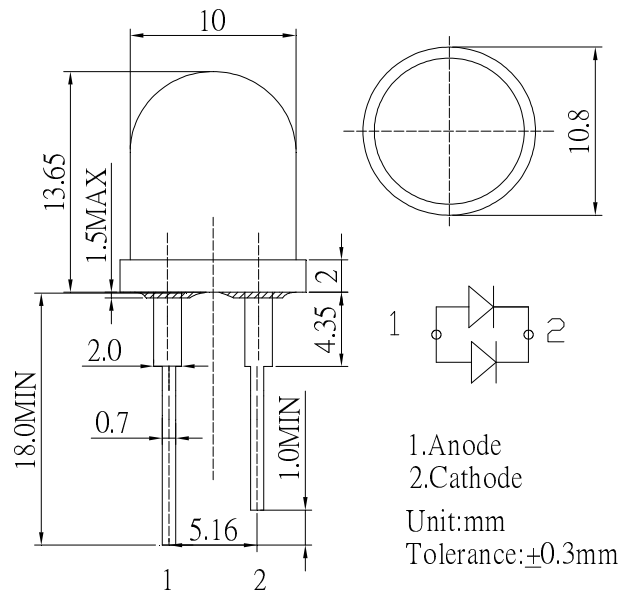

■ Absolute Maximum Rating

(Ta=25°C)

Item	Symbol	Value	Unit
DC Forward Current	I _F	150	mA
Pulse Forward Current#	I _{FP}	200	mA
Reverse Voltage	V _R	5	V
Power Dissipation	P _D	390	mW
Operating Temperature	T _{opr}	-30 ~ +85	°C
Storage Temperature	T _{stg}	-40 ~ +100	°C
Lead Soldering Temperature	T _{sol}	260°C/5sec	-

#Pulse width Max 10ms , Duty ratio max 1/10

■ Directivity

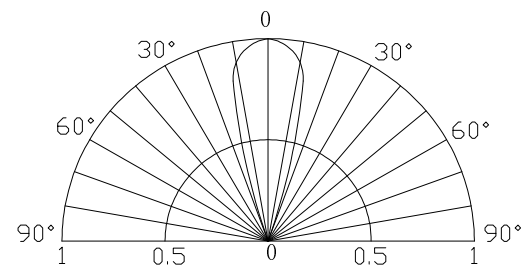

■ Electrical -Optical Characteristics

(Ta=25°C)

Item	Symbol	Condition	Min.	Typ.	Max.	Unit
DC Forward Voltage*	V _F	I _F =130mA	2.0	2.3	2.6	V
DC Reverse Current	I _R	V _R =5V	-	-	20	μA
Luminous Flux*	Φ _v	I _F =130mA	14	18	-	lm
Domi Wavelength*	λ _D	I _F =130mA	585	590	595	nm
50% Power Angle	2θ _{1/2}	I _F =130mA	-	30	-	deg

*1 Tolerance of measurements of dominant wavelength is +1nm

*2 Tolerance of measurements of luminous intensity is +15%

*3 Tolerance of measurements of forward voltage is ±0.1V

LED & Application Technologies

